

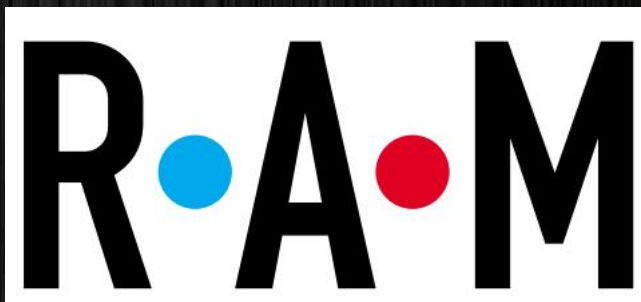

NightSearcher



Lighting The Future



**As leaders in portable and rechargeable LED Lighting, NightSearcher are continuously investing in the research and development of cutting-edge solutions with innovation and product development at the heart of our operation.**

**Since 1989, we have proudly manufactured and delivered professional solutions worldwide, our long heritage and unmatched expertise set us apart as the trusted lighting solution of choice, offering high-quality products and solutions for a wide range of applications and budgets. This has established a creditable reputation that has allowed us to work with a variety of professional organisations, including the Police, Fire & Emergency services, Industrial & Construction industries, Automotive, Rail services, Armed Forces, Sports and Utility companies.**

**At NightSearcher, we are invested in playing our part in the global response to the ongoing threat that climate change presents. We design products with purpose, which support the growing demand for sustainable, zero emission, zero noise alternatives. Our “Think Zero” and “Think Green” ethos demonstrates our commitment and highlights the role that our product portfolio will play in the years to come.**

**NightSearcher also trades under our brands: NexSun – Professional solar lighting (P36), GenZero – Portable, renewable battery generators (P32) and SafATEX - Lighting for use in hazardous environments (P76).**

**We want to thank you, our loyal customers for your continued support and trust that our products make your work safer and easier.**

*Colin Howard* **Managing Director**



NightSearcher’s professional products are carefully designed and manufactured to the highest standards to ensure the reliability and durability our customers need. This is why we offer a 3-year standard warranty on all manufacturing defects and 1-year warranty on all rechargeable batteries from the date of purchase.

\*The warranty can be extended to 5 years (free of charge) that covers defects in manufacturing on all NightSearcher products.

To find out more visit: <https://nightsearcher.co.uk/en/warranty.html>



# New Products

# Contents

*This year we bring you our brightest portable light yet, the NEW StratoStar 115,000 lumen portable tower light. We have also added to our range GenZero portable battery powered generators as well as our NEW LunarStar site lights and many more.*



**StratoStar Tower Light**  
Page 4



**LunarStar 40K + 28K**  
Page 46 to 47



**GenZero Battery Generators**  
Page 32 to 35

**Portable Floodlights**  
Page 4 to 21

**Work Lights**  
Page 22 to 27

**Power Tool  
Work Lights**  
Page 28 to 31

**GenZero Battery  
Powered Generators**  
Page 32 to 35

**NexSun Professional  
Solar Lights**  
Page 36 To 44

**Site Lights**  
Page 45 to 49

**AC Floodlights  
And Security Lights**  
Page 50 to 51

**Searchlights**  
Page 52 to 61

**Flashlights**  
Page 62 to 69

**UV Forensic  
Flashlights**  
Page 70 to 71

**Head Torches**  
Page 72 to 75

**SafaAtex Lights**  
Page 76 to 85

**Hazard Warning  
Lights**  
Page 86 to 91

**Automotive Lights**  
Page 92 to 99

All information is correct at time of press, we reserve the right to alter product specifications at any time and for any reason without liability. Product illustrations and effects may be simulated. Errors and omissions excepted.

# Ideal for Lighting Large Areas

Sectors StratoStar can be used in:

- ✓ Rail
- ✓ Construction and hire
- ✓ Military
- ✓ Sports
- ✓ Highways
- ✓ Emergency and rescue

- ✓ Rechargeable or AC mains supply 110V-240V
- ✓ Fast, safe, one person deployment
- ✓ 48 hour runtime
- ✓ 3850m<sup>2</sup> beam
- ✓ IP67 Rated



2 model available:

115,000 Lumens

3850m<sup>2</sup> beam

3 to 48hrs runtime

**MODE** High | Medium | Low | Dimmable

18Ah or 30Ah LifePO4 Li-ion, 1540Wh

8hrs charging time

IP67 (without powerbank) | IK08

Light head: 438 x 290mm

Light head: 12.7kg, Tripod: 14.3kg  
Battery pack: 22kg

**CODE** NSSTRATOSTAR

Supplied with protective bags, battery pack, tripod and AC mains charger

**Optional Accessories:**

400mm Ground anchors: SPGROUNDANCHORS



Scan for multi-language information



# New StratoStar

115,000 Lumens • Rechargeable Multi-Directional Tower Light



Rechargeable Floodlights

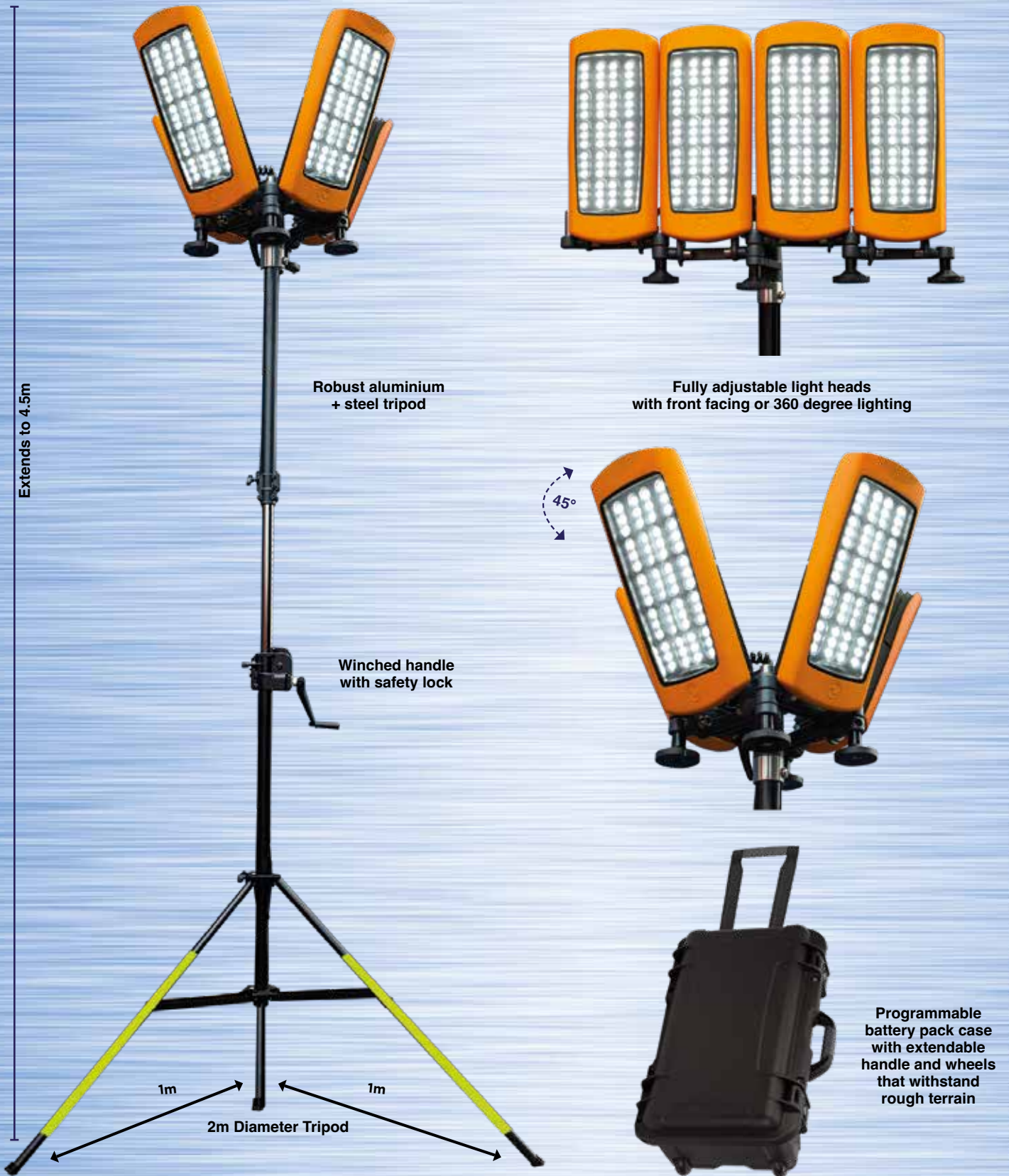

Extends to 4.5m

Robust aluminium + steel tripod

Fully adjustable light heads with front facing or 360 degree lighting

Winched handle with safety lock

45°

1m  
2m Diameter Tripod  
1m

Programmable battery pack case with extendable handle and wheels that withstand rough terrain

- 115,000lm
- 3850m<sup>2</sup> Beam
- 3 to 48hrs
- IP67

- Rechargeable or AC mains powered
- Adjustable runtime 3-48 hours
- Light modes: High, medium, low and dimmable
- 360° lighting or adjusted to one direction
- 4m hand winch tripod with extendable tripod leg for use on uneven ground
- IP67 rated, robust, high-impact housing
- Power bank to charge your phone
- 1540Wh LifePO4 lithium battery
- LCD battery status indicators

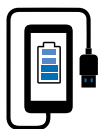

Power bank to charge your phone

# StratoStar Key Features:



Robust aluminium + steel tripod with hand winch and safety locks



IP67 Rated, robust, high-impact housing



LCD programmable display:  
Light mode selection • Programme runtime up to 48 hours • Battery status by colour



Universal DIN spigot fitting (30mm DIN 14640)



Reflective tripod legs for safety



Built-in level gauge



Extendable tripod leg for uneven slopes



Built-in cable wrap

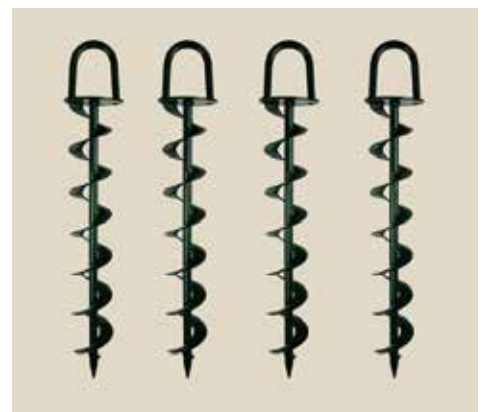

Optional heavy duty ground anchors



# New StratoStar

115,000 Lumens • Rechargeable Multi-Directional Tower Light



Rechargeable Floodlights



Supplied in protective carry bags with carry handle and shoulder straps.



Programmable battery pack case with extendable handle and wheels that withstand rough terrain





2 model available:

	Solaris Pro	Solaris Pro-x
	16,000 Lumens	
	Up to 500m beam	
	2.25 to 24hrs runtime	4.5 to 48hrs runtime
<b>MODE</b>	Boost (Search+Flood)   Search   Flood	
	14.8V 18.2Ah, 270Wh, Li-ion	14.8V 36.4Ah, 540Wh, Li-ion
	6hrs charging time	8hrs charging time
	IP65	
	517 x 155 x 220mm	517 x 155 x 220mm
	7kg	8.5kg
<b>CODE</b>	NSSOLARISPRO Cat No: 0111/122075	NSSOLARISPRO-X Cat No: 0111/115041



Supplied with AC charger and shoulder strap

**Optional Accessories:**

Vehicle charger: CHIC16-8V4A-12-30V

Stability pegs: SPTRIPODPEGS

Folding solar panel charger: SPSOLARPANEL

Carry case: SPSOLARISPROCASE



Scan for multi-language information



**LCD PROGRAMMABLE DISPLAY:**

- Light mode selection
- Programme runtime up to 48 hours (Solaris Pro)
- Battery status by colour





# Solaris Pro

16,000 Lumens, Rechargeable, 48 Hour, Portable Floodlight With Dual Beams



Rechargeable Floodlights



- 16,000lm
- 500m Beam
- 2.25 to 48hrs
- IP65

- Dual optics - Spot and wide beam
- Fast-deployment
- Fully programmable light modes, brightness + runtime
- Telescopic pole Extends to 1.85m with built-in cable to avoid trip hazards
- Built-in stability legs for use on uneven ground
- 4 Angle adjustment, 180° swivel and tilting light head
- 2 Battery options available: 18.2Ah or 36.4Ah
- Lightweight at 7kg or 8.5kg



	<b>6000 Lumens</b>
	<b>Up to 60m beam</b>
	<b>2.5 to 60hrs runtime</b>
<b>MODE</b>	<b>High   Medium   Low   Dimmable</b>
	<b>7.4V 13.2Ah, 98Wh, Li-ion</b>
	<b>8hrs charging time</b>
	<b>IP54   IK08</b>
	<b>310 x 350 x 285mm</b>
	<b>1.5kg</b>
<b>CODE</b>	<b>NSGALAXYPRO-6K CAT no: 0111/111966</b>



Supplied with AC mains charger

**Optional Accessories:**

Tripods: 2m tripod: SPTRIPDSS2M

3.5m tripod: SPTRIPD3.5M

T-Bar bracket: SPGALAXYTWINBAR

**Magnetic mounts:**

Set of 3: SPGALAXYPROMAG

Single large: SPGALAXYMAGMOUNT

AC mains charger: CH8.4V-1.5A

Vehicle charger: CHIC8.4-L-ION



Single large magnet for uneven surfaces



3 Magnets



Scan for multi-language information



# Galaxy Pro 6K

Powerful 6000 Lumens Rechargeable Floodlight, Robust Construction



Rechargeable Floodlights



-  6000lm
-  60m Beam
-  2.5 to 60hrs
-  IP54

- Rechargeable or powered directly from AC mains charger 230V/110V
- Drop tested from 2.5 metres
- Robust housing made from the toughest composite materials
- Charger storage compartment
- Battery status indicator
- Tripod Mountable
- Lightweight - only 1.5kg



Tripod mountable  
check optional  
accessories  
for more details

# 8 Units will Light 60 x 40m Training Pitch

## Perfect for Lighting:

- ✓ Football
- ✓ Rugby
- ✓ Netball
- ✓ Tennis
- ✓ Cricket
- ✓ Basketball courts
- ✓ Personal training  
and many more.....



## TENNIS COURTS

- Youth Level Training – Single Court - 4/6 Kits
- Adult Level Training – Single Court - 6 Kits
- Youth/Adult Level Training – Twin Court - 8 Kits



## Features & Benefits:

- 1 Minute Set Up
- Silent Running
- Weatherproof IP65 Rated
- Unique Optics for Low Light Spills
- Zero Emissions
- Rechargeable Lithium Batteries
- No Maintenance
- Safe Air Cushioned Tripod
- No Planning Permission Required
- Lightweight and Easy to Store

## RUGBY + FOOTBALL

- Training pitch area 8 kits, 60-40m area
- Full training pitch area 16 kits

Grants and Funding Available  
Please call us for help and advice.



	20,000 Lumens - Per light head
	Up to 50m beam
	2 to 16hrs runtime
<b>MODE</b>	High   Medium   Low   Eco
	14.8V 18Ah, 267W, Li-ion
	8hrs charging time
	IP65   IK08
	99 x 20 x 20cm
	9.5kg
<b>CODE</b>	NSSPORTSTARKIT

YouTube



Scan for multi-language information

### Optional Accessories:

- Additional 18Ah power packs: PP14.8 x 18.2PE
- Vehicle charger: CHIC16.8V4A-12/30B
- Hi-Vis sand bags: SPSANDBAG
- Carry bag: SPSPORTSSTARBAG
- Fence adaptor: SP-FENCEADAPTOR
- Set of 3 Ground pegs: SPTRIPDPEGS





# SportStar Kit

Fully Portable and Rechargeable Floodlights with 20,000 Lumens



Rechargeable Floodlights

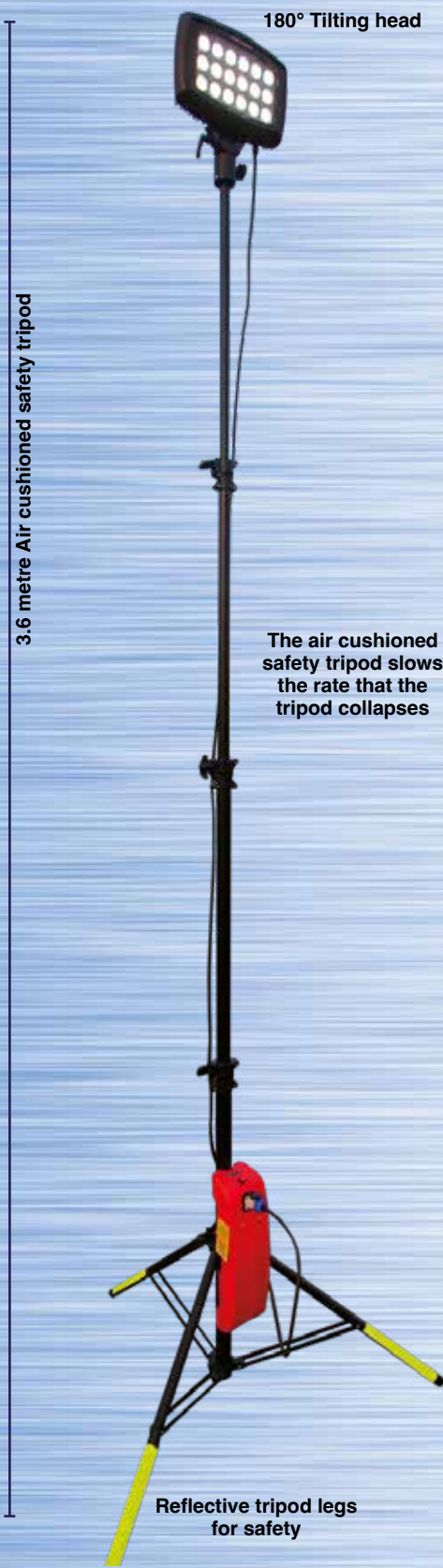

180° Tilting head

3.6 metre Air cushioned safety tripod

The air cushioned safety tripod slows the rate that the tripod collapses

Reflective tripod legs for safety

## Supplied in waterproof carry bag:

- Light head
- Tripod
- Battery pack with shoulder strap
- Mains charger
- 3 x stability ground pegs



## IP65 Battery Pack:

- Weatherproof polyethylene case
- Flame retardant housing
- Swappable battery packs for longer running times
- Hook-on tripod bracket
- Durable polyethylene battery case
- Ground level light modes switch
- Battery charging indicator (Red/Green)



Additional power packs are available for longer runtimes

- 20,000lm Per light head
- 50m Beam
- 2 to 16hrs
- IP65

- Durable all-weather construction
- Rechargeable lithium-ion battery
- 2 to 16 hours runtime from a single charge
- Optional additional batteries for longer running times
- 1 minute setup and operational from ground level
- No planning permission required
- Unique optics for low light spills
- 3.6 metre air cushioned safety tripod

# SportStar Key Features



20,000 Lumens per light head  
Unique optics for low light spills



Floodlight operated from  
ground level switch



IP65 rated, suitable for outdoor  
use all year round



Fits in the boot of your car,  
lightweight and compact to store



All kit fits in waterproof bag  
with shoulder strap 9.5kg



Rechargeable long lasting  
lithium battery and lightweight



Safe, silent operation,  
no mains or generator required



Reflective tripod legs for safety,  
supplied with stability ground pegs



3.6 metre air cushioned  
safety tripod





## NEW Fence Adaptor

Perfect for Tennis, Netball and Basketball Courts

- Avoid any tripod in run off area
- Extends to 3 metres
- Can be permanently left on court, only the light head and battery to remove at the end of the training session.
- Easy to install and operate
- Mounts on all standard sport fencing

NSCODE: SP-FENCEADAPTOR



## Additional 18Ah power packs

For longer runtimes

- IP65 weatherproof rated
- Hook-on tripod bracket
- Durable polyethylene battery case
- On/Off mode switch
- Floodlight can be operated from ground level switch
- Battery status + charging indicator (Red/Amber/Green)

NSCODE: SPP14.8 x 18.2PE

Rechargeable Floodlights



## HI-VIS Sand bags

Perfect for Tennis, Netball and Basketball Courts

- Added stability on hard surfaces
- 7kg (Filled)
- Easily fits over tripod leg

NSCODE: SPSANDBAG (Sand not provided)

Other Sport floodlight available - Call us to find out more:

## Galaxy Pro Sports Kit

12,000 lumens - Ideal for goal training sessions



## StratoStar

115,000 lumens - Lights half a football pitch





# Solaris Duo 40K

High-Power Rechargeable Portable Lighting System with Dual Light Heads

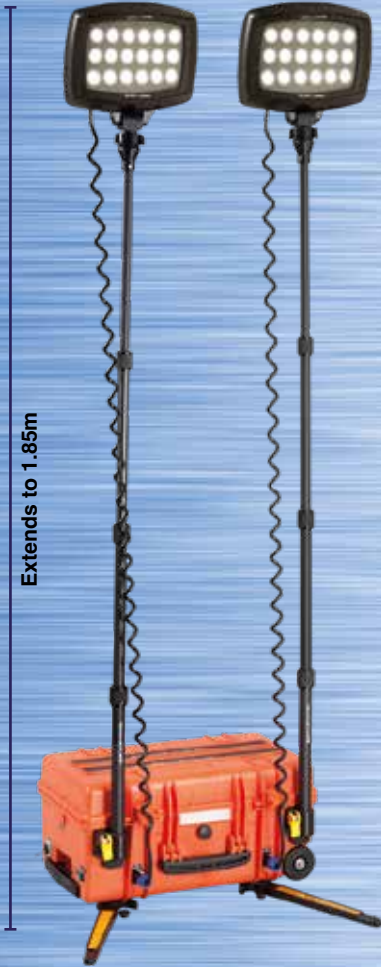

Extends to 1.85m



- 40,000lm
- 100m Beam
- 3 to 24hrs
- IP54/67

- Fast-deployment, all fits in one case
- 2 telescopic extension poles reaching up to 1.85m
- Built-in stability legs for use on uneven ground
- Housed in highly robust IP67 polypropylene case
- Replacement for generator powered lights
- Portable, sturdy and stackable
- Swivel and tilting light head

	40,000 Lumens
	Up to 100m beam
	3 to 24hrs runtime
<b>MODE</b>	High   Medium   Low   Eco
	51Ah, 755Wh, Li-ion
	7hrs charging time
	IP54, IP67 case
	280 x 380 x 570mm
	19.7kg
<b>CODE</b>	NSSOLARISDUO20K-LI-ION-50 Cat no: 0111/112259

Supplied with AC mains charger

**Optional Accessories:**

- Solar panel charger: SPSOLARPANEL
- Vehicle charger: CHIC16.8V4A-12/30V
- Mains charger: CH16.8-8A-LI-ION



Scan for multi-language information





# MegaStar 20K

Rechargeable Portable Lighting Kit, For Lighting Large Remote Areas



3.6 metre Air cushioned tripod



Supplied in waterproof kit bag:

- Light head
- Tripod
- Battery pack with shoulder strap
- Mains charger

- ☀️ 20,000lm
- ➡️ 50m Beam
- 🕒 2 to 16hrs
- ☔ IP65

- IP65 waterproof polyethylene battery case
- 1 minute set-up, quick and easy to assemble
- Hook-on tripod bracket
- Durable all-weather construction
- Light and easy to carry with shoulder strap 9.5kg
- Floodlight can be operated from a ground-level switch
- Additional power packs available

☀️	20,000 Lumens
➡️	Up to 50m beam
🕒	2 to 16hrs runtime
MODE	High   Medium   Low   Eco
🔋	14.8V 18Ah, 267Wh, Li-ion
⚡	8hrs charging time
☔	IP65
📏	75 x 30 x 15mm
📖	9.5Kg
CODE	NSMEGASTARKIT

**Optional Accessories:**

Power pack: PP14.8X18.2PE

Stability ground pegs: SPTRIPODPEGS

Hi-Vis sand bags: SPSANDBAG



**IP65 BATTERY PACK:**

- Durable polyethylene case
- Battery status + charging indicators
- Light modes operated from battery pack



# Upgraded Solaris MegaStar + Maxi 20K

Rechargeable, Portable, 20,000 Lumens Floodlight with a New Battery Power Pack



Extends to 3.5m

Solaris MegaStar



Extends to 1.5m

Solaris Maxi



- 20,000lm
- 50m Beam
- 2 to 28hrs
- IP65

- Portable LED floodlight kit
- Large area illumination coverage
- Robust polypropylene case
- Safe, environmentally friendly operation
- Quick and easy to assemble
- Carry handle, easy to transport and store
- Battery status indicator

2 model available:

	Solaris MegaStar	Solaris Maxi
	20,000 Lumens	
	Up to 50m beam	
	24Ah: 2hrs 15min to 18hrs runtime   38Ah: 3.5 to 28hrs runtime	
MODE	High   Medium   Low   Eco	
	24Ah SLA   38Ah, SLA	
	7hrs charging time (24Ah)   10hrs charging time (38Ah)	
	IP65	
CODE	NSSOLARISMEGASTAR-24 NSSOLARISMEGASTAR-38	NSSOLARISMAXI-24 NSSOLARISMAXI-38

Supplied with AC charger



## UPGRADED POWER PACK:

- Durable polycarbonate case
- Battery status + charging indicators
- Light modes operated from battery pack
- Carry handle



Scan for multi-language information





# Galaxy 12000

Professional and Powerful Slimline Design



Rechargeable Floodlights



- 12,000lm
- 110m Beam
- 2 to 9hrs
- IP64

- Rechargeable, can be powered directly from AC Charger
- Robust housing
- Slimline design
- 180° Swivel stand, lights can be independently angled
- Tripod mountable
- Battery status + charging indicator
- Control panel including thermo sensor and battery status indicator

	12,000 Lumens
	Up to 110m beam
	2 to 9hrs runtime
<b>MODE</b>	High   Medium   Low
	11.1V 5.2Ah, 578Wh, Li-ion
	3hrs charging time
	IP64
	280 x 210 x 138mm
	2.63kg
<b>CODE</b>	NSGALAXY12000

Supplied with AC mains charger and tripod mounting brackets

**Optional Accessories:**  
 2m Stainless tripod: SPTRIPODSS2M  
 3.5m tripod: SPTRIPOD3.5M



Tripod mountable  
check optional  
accessories  
for more details



- Control panel including thermo sensor
- Battery status indicator
- Can be powered directly from AC charger



# Tower Pro Range

Collapsible Hybrid-Powered Floodlight, Rechargeable + AC Powered

## Tower Pro 2K + 7K

### Tower Pro 2K

- 2,000lm
- 30m Beam
- 2 to 8.5hrs

### New Tower Pro 7K

- 7,000lm
- 95m Beam
- 1.5 to 5hrs

Work light

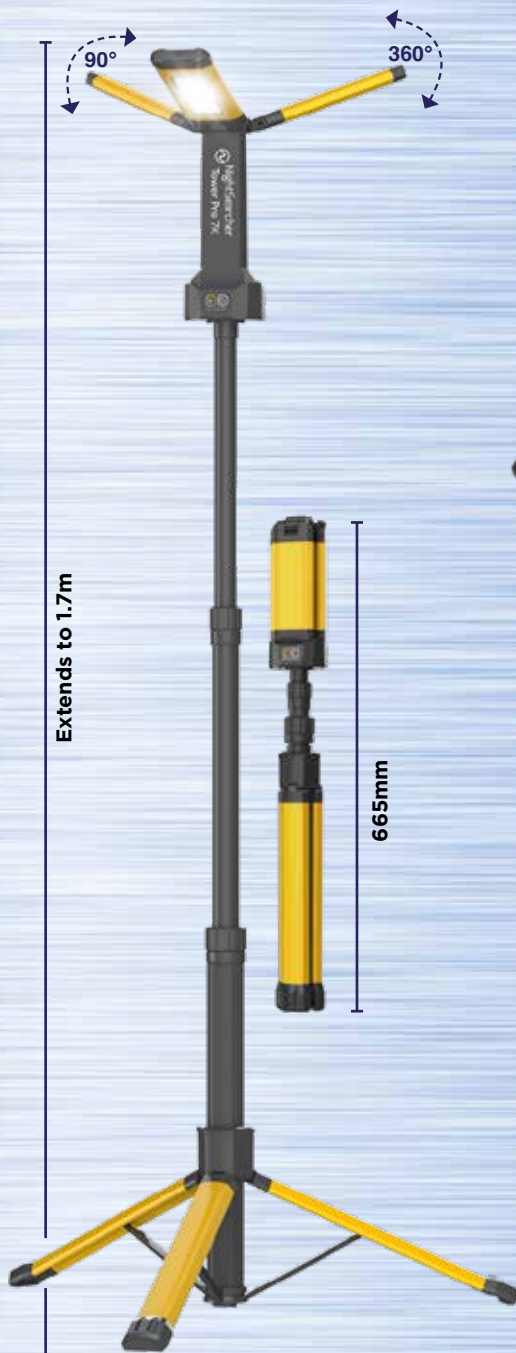

Detachable light head:

- Hanging hook
- Magnetic Base



4 models available:

	Tower Pro 2K	Tower Pro 5K	New Tower Pro 7K	New Tower Pro 10K
	2,000lm	5,000lm	7,000lm	10,000lm
	Up to 30m beam	Up to 90m beam	Up to 95m beam	Up to 110m beam
	2 to 8.5hrs runtime	1 to 5hrs runtime	1.5 to 5hrs runtime	1.5 to 5hrs runtime
<b>MODE</b>	High   Medium   Low			
	3.7V 4000mAh 15Wh, Li-ion	7.4V 4000mAh 30Wh, Li-ion	7.4V 4000mAh 30Wh, Li-ion	14.4V 4000mAh 58Wh, Li-ion
	4hrs charging time	6hrs charging time	6hrs charging time	4.5hrs charging time
	IP x 4   IK07	IP x 4   IK07	IP54   IK07	IP54   IK07
	95 x 100 x 1700mm Folded: 80 x 665mm	160 x 122 x 2000mm Folded: 122 x 160 x 890mm	95 x 100 x 1700mm Folded: 80 x 665mm	150 x 150 x 2200mm Folded: 150 x 647mm
	1.8kg	4.5kg	3.5kg	5.49kg
<b>CODE</b>	NSTOWERPRO-2K	NSTOWERPRO-5K	NSTOWERPRO-7K	NSTOWERPRO-10K

Supplied with  
2K/7K: Type C charging USB cable and carry case | 5K/10K: AC charger and carry case

20 www.nightsearcher.co.uk





## Tower Pro 5K + 10K



- Portable, collapsible design, quick and easy to setup
- Multi-angle rotational lights
- Can be powered direct from AC mains (medium mode only)
- Robust housing
- Switch & brightness control panel
- Warm white and cool white light modes
- Battery charging indicator
- Supplied with carry case



YouTube  
 Scan for multi-language information



# New Roo-Star 500

Rechargeable Slim Keylight with Powerful Flood Beam



Fits on your key ring

- 500lm
- 0.5 to 8hrs
- IP54

- Compact and powerful 500 lumens
- Easily fits on your backpack, handbag or pocket
- Magnetic base and back for hands-free operation
- Rechargeable lithium battery
- Tough aluminium housing
- Fast charging USB Type C connection

	<b>500 Lumens</b>
	<b>0.5 to 8hrs runtime</b>
<b>MODE</b>	<b>Boost   High   Medium   Low</b>
	<b>3.7V 300mAh, 2Wh, Li-ion</b>
	<b>1hr charging time</b>
	<b>IP54   IK07</b>
	<b>60 x 27.5 x 15mm</b>
	<b>34g</b>
<b>CODE</b>	<b>NSROO-STAR500</b>

Supplied with USB-C fast charging cable

**Optional Accessories:**

UK or EU adaptor: CH-USB-UK/EU

12/24V Vehicle charger: CHIC3.7-LI-ION



Scan for multi-language information





# New Roo-Star 1200

Rechargeable Slim Inspection Light with Powerful Spot and Flood Beam

Rechargeable Work Lights



- 1200lm
- 1.5 to 12hrs
- IP54

- Compact design that easily fits in your pocket or in your toolbox
- Wide floodlight and dimmable
- Narrow spot beam
- Magnetic base for hands-free operation
- Rechargeable lithium battery
- Tough aluminium housing
- Fast charging USB Type C connection

	1200 Lumens
	1.5 to 12hrs runtime
<b>MODE</b>	Flood: High   Medium   Low   Dimmable   Spot: High
	3.7V 2000mAh, 3.7Wh, Li-ion
	3hrs charging time
	IP54   IK07
	115 x 46 x 26mm
	147g
<b>CODE</b>	NSROO-STAR1200

Supplied with USB-C fast charging cable

**Optional Accessories:**

UK or EU adaptor: CH-USB-UK/EU

12/24V Vehicle charger: CHIC3.7-LI-ION



# New Duo Star

Rechargeable, Double Sided Spot and Work Light



Wide Angled Flood Beam



Narrow Spot Beam

Hanging hooks



- 550lm
- 4.5 to 9hrs
- IPX4

- Fits in the palm of your hand
- Fully adjustable lamp head
- Robust housing
- Magnetic base
- Hanging hooks
- Battery status and charging indicator

	550 Lumens
	4.5 to 9hrs runtime
<b>MODE</b>	Flood: High   Dimmable Spot: High   Low   Dimmable
	3.7V 2000mAh, 4.7Wh, Li-ion
	3.5hrs charging time
	IPX4   IK07
	72 x 76 x 49.5mm
	170g
<b>CODE</b>	NSDUOSTAR

Supplied with Type C USB charging cable

**Optional Accessories:**

UK or EU adaptor: CH-USB-UK/EU

12/24V Vehicle charger: CHIC3.7-LI-ION



Scan for multi-language information



# New Nova Star

High Powered Multi-Functional Work Light, with Fold Flat Design

Rechargeable Work Lights



- 2000lm
- 50m Beam
- 1.5 to 5hrs
- IPX7

- Fully adjustable lamp head
- Free-standing, elevated lighting
- Rechargeable lithium battery
- Powerbank to charge your phone
- Robust housing
- Red flashing emergency mode
- Battery status indicators



59mm Slim fold flat design for easy storage

	2000 Lumens
	Up to 50m beam
	1.5 to 5hrs runtime
<b>MODE</b>	High   Medium   Low   Red   Red Flashing
	3.7V 4000mAh, 15Wh, Li-ion
	5.5hrs charging time
	IPX7   IK07
	180 x 59 x 115mm
	680g
<b>CODE</b>	NSNOVASTAR

Supplied with USB-C fast charging cable

**Optional Accessories:**

- UK or EU adaptor: CH-USB-UK/EU
- 12/24V Vehicle charger: CHIC3.7-LI-ION
- Tripods: 2m tripod: SPTRIPODSS2M



Flashing red emergency light

- Magnetic base
- Hanging hook
- Wall hanging slots
- Tripod mountable



@valetnova



@valetnova



Power bank to charge your phone



Tripod mountable check optional accessories for more details

# Galaxy 1200

## Robust, Heavy-Duty Rechargeable Work Light



- 1200lm
- 50m Beam
- 3 to 7hrs
- IP54



- Compact, fold flat design
- Robust edge protection
- USB rechargeable
- Ultra powerful magnetic handle
- Battery status + charging indicator
- Power bank to charge your mobile

	1200 Lumens
	Up to 50m beam
	3 to 7hrs runtime
<b>MODE</b>	High   Medium   Flashing
	3.7V 4400mAh, 16.28Wh, Li-ion
	9hrs charging time
	IP54   IK07
	168 x 127 x 55mm
	491g
<b>CODE</b>	NSGALAXY1200

Supplied with USB charging cable

**Optional Accessories:**  
 UK or EU adaptor: CH-USB-UK/EU  
 12/24V Vehicle charger: CHIC3.7-LI-ION  
 Tripods: 2m tripod: SPTRIPODSS2M



Tripod mountable  
check optional  
accessories  
for more details



Power bank to  
charge your phone



# Galaxy Star

## Incredibly Power And Bright Work



- 2800lm
- 90m Beam
- 1.6 to 11hrs
- IP54



Optional  
magnetic mount and  
scaffold bracket

- Robust edge protection
- Compact, fold flat design
- USB rechargeable
- Battery status and charging indicator
- Industrial strength aircraft grade aluminium
- Optional magnetic mount and scaffold bracket

	2800 Lumens
	Up to 90m beam
	1.6 to 11hrs runtime
<b>MODE</b>	100%   70%   45%   35%   20%
	7.4V 2200mAh, 8.14Wh, Li-ion
	3.5hrs charging time
	IP54   IK07
	170 x 170 x 48mm
	701g
<b>CODE</b>	NSGALAXYSTAR

Supplied with USB charging cable

**Optional Accessories:**  
 UK or EU adaptor: CH-USB-UK/EU  
 12/24V Vehicle charger: CHIC3.7-LI-ION  
 Tripods: 2m tripod: SPTRIPODSS2M



Tripod mountable  
check optional  
accessories  
for more details

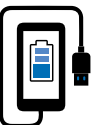

Power bank to  
charge your phone





# Galaxy 1000 and 2000

Compact, Lightweight and Portable Work Lights

Rechargeable Work Lights



Fold flat for easy storage



- |               |           |
|---------------|-----------|
| 1000lm        | 2000lm    |
| 10m Beam      | 20m Beam  |
| 1.4 to 3.2hrs | 2 to 4hrs |
| IP54          | IP54      |

- High impact ABS housing
- Shatterproof polycarbonate lens
- Carry handle and floor stand
- Rechargeable lithium battery
- Overcharge and discharge protection
- Battery charging indicator
- Lightweight under 730g
- Ideal for DIY, inspection work and construction sites

2 models available:

	Galaxy 1000	Galaxy 2000
	1000 Lumens	2000 Lumens
	Up to 10m beam	Up to 20m beam
	1.4 to 3.2hrs runtime	2 to 4hrs runtime
MODE	High   Low	High   Low
	Li-ion 3.7V 4000mAh, 15Wh	7.4V 4000mAh, 30Wh, Li-ion
	3.5hrs charging time	6.5hrs charging time
	IP54	IP54
	72 x 76 x 49.5mm	72 x 76 x 49.5mm
	539g	730g
CODE	NSGALAXY1000	NSGALAXY2000

360° handle and stand



Supplied with GALAXY1000: USB charging cable  
Galaxy 2000: USB-DC1 charging cable

Optional Accessories:  
UK or EU adaptor: CH-USB-UK/EU  
12/24V Vehicle charger: CHIC3.7-LI-ION  
Tripods: 2m tripod: SPTRIPODSS2M



Tripod mountable  
check optional  
accessories  
for more details

YouTube  
Scan for multi-language information



# Work Lights Powered by Power Tool Batteries



**Compatible with the most popular power tool batteries:**  
18-21V Makita, Dewalt, Milwaukee, Bosch, Stanley, Porter Cable, Black & Decker (Not supplied)  
(Metabo, Festool, Hilti - optional adaptors)



**WorkStar Connect**  
Accepts one power tool battery



Supplied with 4 x power tool battery adaptors



**TwinStar Connect**  
Accepts up to two power tool batteries

## Upgraded WorkStar Connect



Hanging hook

3,000lm

30m Beam

2 to 16hrs

IP54

- Accepts batteries from 11 leading power tool brands
- Robust construction with toughened glass lens
- Strong magnetic base
- Adjustable stand with hanging hook
- USB powerbank to charge your mobile devices
- Compact, fold flat design for easy storage
- IK07 shock proof
- Tripod mountable

	3000 Lumens
	Up to 30m beam
	2 to 16hrs runtime
<b>MODE</b>	High   Medium   Low
	Powered by power tool batteries 18-21V Makita, Dewalt, Milwaukee, Bosch, Stanley, Porter Cable, Black & Decker (Metabo, Festool, Hilti - optional adaptor)
	IP54 (without battery)
	225 x 90 x 340mm
	1kg
<b>CODE</b>	NSWORKSTARCONNECT

Supplied with 4 power tool adaptors

### Optional Accessories:

Power tool adaptor (18-21V batteries):  
Metabo: SPWORKSTARCONNECT-AD-A  
Festool: SPWORKSTARCONNECT-AD-B  
Hilti: SPWORKSTARCONNECT-AD-C  
Quick release tripod: SPTRIPOD1.6-CON



Power bank to charge your phone



Tripod mountable check optional accessories for more details





# New TwinStar Connect

Multi-Angled Twin Head Light, With Power Tool Battery Adapters

Power Tool Work Lights



Supplied with 4 x power tool battery adaptors

Removable Light head



Compact folding design



Extends to 1.6m

- 12,000lm
- 50m Beam
- 1 to 8hrs
- IP54

- Accepts batteries from 11 leading power tool brands
- Quick and easy to setup
- 2 x Power/ Light mode switch, to turn on 1 or both light heads
- Multi-angled light heads
- 5000K Daylight illumination
- Carry handle
- Removable light head, with supplied quick release tripod

	12,000 Lumens, 6000 per light head
	Up to 50m beam
	1 to 8hrs runtime
<b>MODE</b>	High   Medium   Low
	Powered by power tool batteries 18-21V Makita, Dewalt, Milwaukee, Bosch, Stanley, Porter Cable, Black & Decker (Metabo, Festool, Hilti- optional adaptor)
	IP54 (without battery)
	Light head: 475 x 170 x 140mm
	Light: 1.8kg   Tripod: 2.1kg
<b>CODE</b>	NSTWINSTARC



Optional carry bag:  
SPTWINSTARBAG

Supplied with 4 Power tool adaptors and 1.6m tripod

**Optional Accessories:**

- Power tool adaptor (18-21V batteries):
- Metabo: SPWORKSTARCONNECT-AD-A
- Festool: SPWORKSTARCONNECT-AD-B
- Hilti: SPWORKSTARCONNECT-AD-C



Scan for multi-language information





3 model available:

	KangaStar 2K	KangaStar 5K	KangaStar 10K
	2,200 Lumens	5,000 Lumens	10,000 Lumens
	Up to 25m beam	Up to 50m beam	Up to 100m beam
	5.5 to 22hrs (6Ah battery)	3 to 15 hours runtime (6Ah battery)	1.5 to 7.5hrs (6Ah battery)
MODE	High   Medium   Low	20%   40%   60%   80%   100%	20%   40%   60%   80%   100%
	IP65 (without battery)		
	215mm x 150mm x 98mm	290mm x 145mm x 265mm	265mm x 145mm x 360mm
	1.24kg	2.9kg	3.1kg
CODE	NSKANGASTAR-2K	NSKANGASTAR-5K	NSKANGASTAR-10K



Tripod mountable  
check optional  
accessories  
for more details



YouTube  
Scan for  
multi-language  
information

Supplied with:

**KangaStar 2K**  
Choose integrated  
A or B power tool adaptor:



**KangaStar 5K and 10K**  
Choose either A or B power tool adaptor:

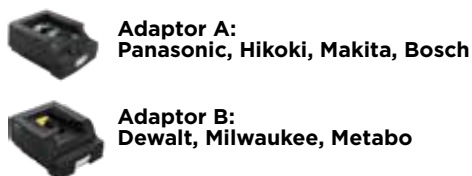

Optional accessories:

**KangaStar 5K and 10K**



3.5m tripod: SPTRIPOD3.5M  
T-Bar for tripod: SPTBARSS-KANGA



# Work Lights Powered by Power Tool Batteries



Compatible with the most popular power tool batteries:  
 14.4V + 18 Dewalt, Milwaukee, Makita, Hikoki (Hitachi),  
 Bosch, Panasonic, Metabo (Not supplied)  
 (Flex , Festool, Einhell, Parkside - optional adaptor)



## New KangaStar 2K | 5K | 10K Work Lights

### 3-in-1 Power Supply System:

- ❶ Power Tool Adaptor
- ❷ 6Ah Battery (5K + 10K)
- ❸ AC Mains (5K + 10K)



**2K** 2,000lm  
 25m Beam  
 5.5 to 22hrs

**5K** 5,000lm  
 50m Beam  
 3 to 15hrs

**10K** 10,000lm  
 100m Beam  
 1.5 to 7.5hrs

- Accepts batteries from 11 leading power tool brands
- Robust aluminium construction with tempered glass lens
- Convex Lens for improved optics
- IP65 Rated, Impact resistant aluminium housing
- Hanging hooks
- Tripod mountable (5K + 10K model)
- Magnetic base (2K model)



100 METRE BEAM

# GENZERO

ZERO EMISSIONS – MAXIMUM POWER

RECHARGEABLE, BATTERY POWERED GENERATORS



Introducing **GenZero**, NightSearcher's innovative range of battery powered generators. A selection of three portable generators designed to provide reliable and efficient power to areas where it's needed the most. Perfect for both industrial and residential applications.

**GenZero** generators provide maximum electric power with zero emissions. NightSearcher is committed to promoting a greener, cleaner way of working that helps the environment and businesses off-set their carbon neutral footprint.

## GenZero 500W

500Wh Capacity Battery



## GenZero 800W

2000Wh Capacity Battery



## GenZero 1800W

3000Wh Capacity Battery



 **YouTube**  
Scan for multi-language information



**GenZero** delivers safe and reliable power to areas with restricted access to an electricity supply:



Ideal for emergency power in natural disasters



Flexible power supply for tools and lighting on remote sites



Highly portable for camping and other recreational uses



Reliable pure sine-wave inverter energy and LCD displays



Housed within super-tough, rugged IP66 protective case



240V or 110V Power supply (800W and 1800W)





## New GenZero 500W 500Wh Capacity Battery

### Small Generator for Home, Work and Recreation

- Easily powers a selection of home appliances such as kettles, TV, air pumps, mini-refrigerators, laptop and more
- Wireless charger for your mobile
- 3 hours fast charging (80%)
- Ideal in the event of a power cut
- LED light
- Digital LCD display
- Multiple charging outputs
- Operates at 50-60Hz AC across its fixed voltage supply of 230V and provides pure sine wave AC output
- Carry handle for easy transportation
- Housed in a rugged, durable case and lightweight design at only 5kg

**500W**  
CONTINUOUS OUTPUT

**800W**  
PEAK OUTPUT





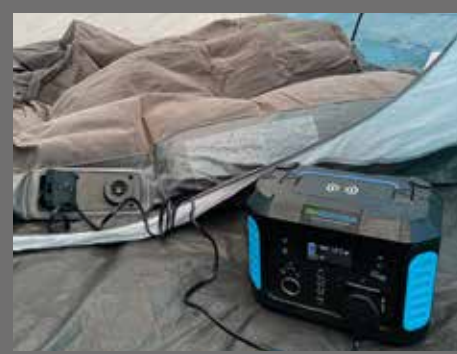

Continuous Output	500W
Peak Output	800W
Battery Capacity	500Wh
Battery Type	Rechargeable Lithium Battery
Charging Time	3hrs (80%) - 4hrs (100%)
AC Output Voltage	230V
DC Outputs	12V/10A (Max)
USB Outputs	2 x Type-C Output: PD60W 2 x USB-A Output:12V/1.5A
Charging Input	12-24VDC 5A adaptor
Charge Methods	AC-DC mains charger Solar panel charger Vehicle charger
Frequency Range	50-60Hz
Sine Wave Type	Pure Sine Wave
Life of Battery	More than 1000 cycles
IP Rating	IP44/IP54/IP65 depending on AC output plug fitted
Supplied with	AC Mains Adaptor
Net Weight	5kg
Dimension	241Lx161Wx181H mm
NS Code	GENZERO-500W-230V



More models coming soon, contact us for more details: [sales@nightsearcher.co.uk](mailto:sales@nightsearcher.co.uk) | +44 (0)23 9238 9774



#### Product discharge time examples:

 Recharged 32 times	 35W 13.5 Hours
 75W 7 Hours	 40W 12 Hours

# New GenZero 800W

## 2000Wh Capacity Battery

### Industrial Portable Power Station

- Provide maximum electric power on large or remote sites with zero emissions
- An efficient, reliable power supply for site lighting or equipment
- Ideal for emergency power in natural disasters and powering household appliances
- Housed within super-tough, rugged IP66 protective case
- 3 hours fast charging (80%)
- LCD digital display, safe and easy to operate
- Offer powerful and super-efficient 230V or 110V portable power supply and provides reliable pure sine-wave inverter energy
- Can be charged from AC mains, DC output or solar
- Highly portable can be carried by one person
- Includes safety system protection including overcharge/discharge, overload over temperature, short-circuit and under-voltage



**800W**  
CONTINUOUS OUTPUT

**1600W**  
PEAK OUTPUT



Continuous Output	800W
Peak Output	1600W
Battery Capacity	2000Wh
Battery Type	Rechargeable Lithium Battery
Charging Time	3hrs (80%) - 8hrs (100%)
AC Output Voltage	230V or 110V
DC Outputs	12V/10A (Max)
USB Outputs	-
Charging Input	29V DC 10A adaptor
Charge Methods	AC-DC mains charger Solar panel charger Vehicle charger
Frequency Range	50-60Hz
Sine Wave Type	Pure Sine Wave
Life of Battery	More than 1000 cycles
IP Rating	IP44/IP54/IP65 depending on AC output plug fitted
Supplied with	AC Mains Adaptor
Net Weight	15.5kg
Dimension	408Lx311Wx166H mm
NS Code	GENZERO-800W-110V GENZERO-800W-230V



More models coming soon, contact us for more details: [sales@nightsearcher.co.uk](mailto:sales@nightsearcher.co.uk) | +44 (0)23 9238 9774

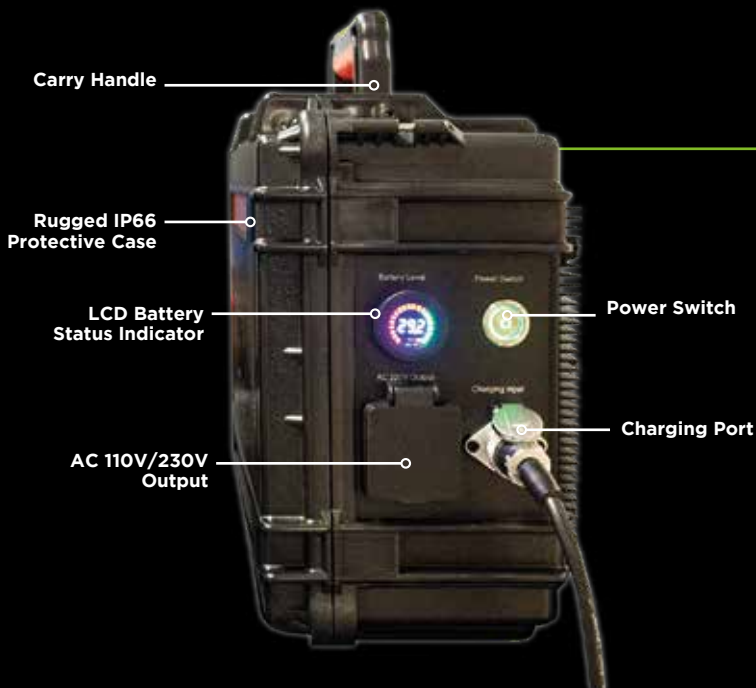

Product discharge time examples:



45W  
40 Hours

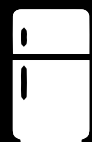

150W  
12 Hours



300W  
6 Hours



800W  
2 Hours



# New GenZero 1800W 3000Wh Capacity Battery

## Industrial Portable Power Station

- Provide maximum electric power on large or remote sites with zero emissions
- An efficient, reliable power supply for site lighting or equipment
- Ideal for charging tools and supporting remote working devices
- 2 hours fast charging (80%)
- Highly portable, carry case with extendable handle and wheels
- Housed within super-tough, rugged IP66 protective case
- LCD digital display, safe and easy to operate
- Offer powerful and super-efficient 230V or 110V portable power supply and provides reliable pure sine-wave inverter energy
- Can be charged from AC mains, DC output or solar
- Recharges in only 6 hours
- Includes safety system protection including overcharge/discharge, overload over temperature, short-circuit and under-voltage

**1800W**  
CONTINUOUS OUTPUT

**3600W**  
PEAK OUTPUT



Continuous Output	1800W
Peak Output	3600W
Battery Capacity	3000Wh
Battery Type	Rechargeable Lithium Battery
Charging Time	2hrs (80%) - 4hrs (100%)
AC Output Voltage	230V or 110V
DC Outputs	12V/3A (Max)
USB Outputs	5V/1A
Charging Input	54.6V DC 10A adaptor
Charge Methods	AC-DC mains charger Solar panel charger Vehicle charger
Frequency Range	50-60Hz
Sine Wave Type	Pure Sine Wave
Life of Battery	More than 1000 cycles
IP Rating	IP44/IP54/IP65 depending on AC output plug fitted
Supplied with	AC Mains Adaptor
Net Weight	25kg
Dimension	348Lx205Wx458H mm
NS Code	GENZERO-1800W-110V GENZERO-1800W-230V



More models coming soon, contact us for more details: [sales@nightsearcher.co.uk](mailto:sales@nightsearcher.co.uk) | +44 (0)23 9238 9774



### Product discharge time examples:



45W  
60 Hours



800W  
4 Hours



180W  
17 Hours



300W  
9 Hours

At NightSearcher, we are invested to play our part in the global push to address concerns for the climate and environment. NexSun forms part of our “Think Zero” and “Think Green” ethos which highlights the benefits of portable rechargeable and solar technology, and the vital role they’ll both play for years to come.

Zero emissions, zero cables, zero noise, all encompass our product range in the drive for a greener, safer and sustainable environment for us all.



Scan to view  
NEXSUN.CO.UK

## NexSun 2000

Slim, Modern Solar Flood Light, with PIR Sensor



	<b>2000 Lumens</b>
	<b>Up to 45m Flood beam</b>
	<b>8hrs runtime</b>
<b>MODE</b>	<b>PIR Sensor mode Set timer mode</b>
	<b>4 Metres</b>
	<b>6.8W Mono-crystalline</b>
	<b>3.7V 2000mAh, Li-ion</b>
	<b>7.5hrs charging time</b>
	<b>IP65</b>
	<b>Straight pole mount Wall mount</b>
	<b>452 x 246 x 85mm</b>
	<b>2kg</b>
<b>CODE</b>	<b>NEXSUN-2000</b>



Scan for  
multi-language  
information

Supplied with 2 x U shaped bracket, fixings and remote control

- 2000lm
- 45m Beam
- 8hrs
- IP65

- Slim modern design
- Automatically turns ON/OFF dusk till dawn
- Optical lens anti-glare light
- Motion sensor that can reaches up to 4 metres
- Manual on/off switch or remote control operated
- Simple to install with no wiring required
- Operate for 10 continuous nights without recharge





# NexSun 1800 & 5000

Slim, Modern Solar Flood Light, with PIR Sensor



Remote Control (NexSun 5000)

## NexSun 1800

## NexSun 5000

1800lm

5000lm

12hrs

12hrs

IP65

IP65

- Slim modern design with optical lens anti-glare light
- Automatically turns ON/OFF dusk till dawn
- Wide angled motion sensor that can reaches up to 8-12 metres
- Next generation LiFePO4 battery (NexSun 5000 only)
- Simple to install with no wiring required
- Features temperature control system to optimise battery power
- Battery status indicators

2 models available:

	NEXSUN 1800	NEXSUN 5000
	1800 Lumens	5000 Lumens
	8 Metres	8-12 Metres
	12hrs runtime	
<b>MODE</b>	PIR Sensor mode	PIR Sensor mode   Set timer mode
	7.4V 5800mAh, Li-ion	9.6V 1200mAh, LiFePO4 lithium battery
	5-6hrs charging time	8-10hrs charging time
	IP65	
	Straight pole mount   Wall mount	
	493 x 232 x 58mm	700 x 290 x 74mm
	3kg	5.2kg
<b>CODE</b>	NEXSUN-1800	NEXSUN-5000



Supplied with 1 x Arch shaped bracket  
2 x U shaped bracket and fixings and remote control.



# NexSun 2500

Ultra-modern, Slimline Rechargeable Modular Solar Powered Flood Light



2500lm

35m Beam

15hrs

IP65

- Automatically turns ON/OFF dusk till dawn
- 15 metres Microwave motion sensor
- Ideal for where no AC mains power exists
- Manual on/off switch or remote control operated
- LiFePO4 high capacity lithium battery
- Flood light is housed in aircraft grade aluminium
- Battery status Indicator



2500 Lumens



Up to 35m Flood beam



Up to 15hrs

MODE

Sensor mode | Dim mode | Set timer mode



4 Metres



1W Mono-crystalline



115WH 6.4V LiFePO4 lithium battery



9-10hrs Charging time



IP65



Wall mount | Ceiling mount | Tripod mount



Floodlight: 375 x 275 x 45mm  
Solar panel: 660 x 350mm



5kg

CODE

NEXSUN-2500

Supplied with 4.5 metre cable and remote control



# NexSun 2500RC

Rechargeable Solar Linear Light with a High-Powered Solar Panel



2500lm

5m Beam

12hrs

IP65

- Ideal replacement for fluorescent fittings in sheds and garages
- Automatically turns ON/OFF dusk till dawn
- Light can be ON/OFF like a regular light by wall mounted switch
- Robust Polycarbonate and aluminium housing
- Adjustable mounting bracket



2500 Lumens



Up to 5m, 120° Flood beam



Up to 12hrs runtime

MODE

Sensor mode | Dim mode | Set timer mode



8 Metre



18W Mono-crystalline



154WH 12.8V LiFePO4 lithium bat



6hrs charging time



IP65



Wall mount | Ceiling mount



92 x 48 x 600mm



2.8kg

CODE

NEXSUN-2500RC

Supplied with 5 metre cable, wall switch and remote control





# NexSun Bollard Light

Multi-Coloured Cylinder & Square Bollard Lights



High impact polycarbonate light head with ultra bright mirror reflector



Wireless remote which control up to 50 lights from 25 metres away



Choose between cold and warm white glow or any spectrum of colour

- 220lm
- 16hrs
- IP65

- Durable, corrosion resistant stand and polycarbonate light head
- Automatically turns ON/OFF dusk till dawn
- Choose between cold and warm white glow or any spectrum of colour
- No 240V AC Mains connection required
- LiFePO4 high capacity lithium battery
- Low install costs with minimal site impact
- Perfect for illuminating any driveway, pathway or garden patio

2 models available:

	CYLINDER BOLLARD	SQUARE BOLLARD
	220 Lumens	
	Up to 16hrs runtime	
<b>MODE</b>	Cool   Warm White Light Full Colour Spectrum   Dimmable	
	6.2W Mono-Crystalline	
	12,000mAh 3V LiFePO4 lithium battery	
	6hrs charging time	
	IP65	
	225 x 255 x 90mm	
	4.4kg	
<b>CODE</b>	NEXSUN-BOLLARD-C	NEXSUN-BOLLARD-S



Supplied with remote control



# NexSun 400

Solar Powered Garden Feature and Security Light



Optional:  
Anti-theft stainless  
steel tie wraps

- 400lm
- 10m Beam
- 8hrs
- IP65

- Increasing security around your home & garden
- Automatically turns ON/OFF dusk till dawn
- Compact, modern wedge design
- Durable ABS plastic housing
- Installs in Minutes - No wiring
- Ideal for providing lighting to driveways, sheds and garages with no mains power required

	400 Lumens
	Up to 10m Flood beam
	Up to 8hrs
<b>MODE</b>	Sensor mode   Dim mode   Always on mode
	10 Metres, Lights up for 30 seconds when activated
	Mono-crystalline
	2000mAh 3.7V lithium battery
	8hrs Charging time
	IP65
	Wall mount   Bracket Mount (optional extra)
	115 x 103 x 42mm
	200g
<b>CODE</b>	NEXSUN-400   Cat No: 0111/114275



Supplied with fixings

**Optional Accessories:**

Anti theft bracket: SPSOLARBRACKET



# NexSun 1100RC

Solar Powered Garden Feature and Security Light



Optional:  
Anti-theft stainless  
steel tie wraps

- 1100lm
- 20m Beam
- 8hrs
- IP65

- Increasing security around your home & garden
- Automatically turns ON/OFF dusk till dawn
- Modern wedge design
- Durable ABS plastic housing
- Installs in Minutes - No wiring
- Ideal for providing lighting to driveways, sheds and garages with no mains power required

	1100 Lumens
	Up to 20m Flood beam
	Up to 8hrs runtime
<b>MODE</b>	Sensor mode   Power saving mode Always on mode   Automatic power adjust mode Emergency mode
	10 Metres, Lights up for 30 seconds when activated
	Mono-crystalline
	7800mAh 3.7V lithium battery
	8hrs charging time
	IP65
	Wall mount   Bracket Mount (optional extra)
	210 x 140 x 108mm
	600g
<b>CODE</b>	NEXSUN-1100RC   Cat No: 0111/114319



Supplied with fixings

**Optional Accessories:**

Anti theft bracket: SPSOLARBRACKET





# New NexSun 1000SL

Wall Mounted Solar Security & Flood Light



- 1000lm
- 15m Beam
- 10hrs
- IP44

- Increasing security around your home & garden
- Automatically turns ON/OFF dusk till dawn
- Fully adjustable light head
- Lightweight, durable aluminium housing
- Easy to install and easy to maintain
- No 240V AC Mains connection required
- Ideal for use at entrances or dark walkways where constant light is not required

	1000 Lumens
	Up to 15m Flood beam
	Up to 10hrs runtime
<b>MODE</b>	Adjustable sensor mode
	12 Metres, Lights up for 3 sec - 7min when activated
	3.5W Mono-crystalline
	1800mAh 3.7V lithium battery
	10hrs Charging time
	IP44
	Wall mount
	Floodlight: 283 x 189 x 130mm Solar panel: 210 x 160 x 80mm
	1.1kg
<b>CODE</b>	NEXSUN-1000SL   Cat No: 0111/110180



Supplied with fixings

Motion Sensor Controls



**LU x**  
Night - Day  
Adjustable  
Settings



**Light Time**  
Adjustable  
Settings

3 Sec -  
7 Mins

# NexSun 2in1

Wall-mounted LED Security Light with a Detachable Body



Wall mounted with detachable body for use as a portable light

- 1000lm
- 6hrs
- IP65

- Solar powered security light and portable light
- Automatically turns ON/OFF dusk till dawn
- Simple to install with no wiring required
- Single button operation
- Features temperature control system to optimise battery power
- 1.6 metres recommended installation height

	1000 Lumens
	Up to 5m beam
	Up to 6hrs runtime
<b>MODE</b>	Sensor mode   Set timer mode
	5 Metre
	1W Mono-crystalline
	3.7V 2000mAh lithium battery
	10hrs charging time
	IP65   IK10
	80 x 72 x 225mm
	270g
<b>CODE</b>	NEXSUN-2-IN-1



Scan for multi-language information



Supplied with fixings



Mode Indicator Light



Battery Status indicator





# New NexSun Brick Light

Exterior Brick Light That is Perfect for Increasing Security Around your Home and Garden



Simple to operate  
Power on/off + light mode button on the back of the light



- 900lm
- 10m Beam
- 96hrs
- IP65

- Increasing security around your home & garden
- Automatically turns ON/OFF dusk till dawn
- VO Fire proof housing
- Anti UV housing reduces UV damage and fading
- Designed to illuminate a large 140 degree area below, LEDs are protected by tempered glass
- No 240V AC Mains connection required
- Ideal for use in doorways, pathways and outbuildings

	<b>900 Lumens</b>
	Up to 4 nights, (10 Hours Continuously)
<b>MODE</b>	Sensor mode   Energy Saver mode
	140° 6 Metres
	2.8W 5.5V Poly-Crystalline
	3.7V 3000mAh 18650 lithium battery
	10hrs charging time
	IP65
	230 x 97 x 42mm
	570g
<b>CODE</b>	<b>NEXSUN-BRICK</b>



Supplied with fixings



# NexSun Solar Panel

Rechargeable Foldable 48W Solar Panel - Recharge Products On The Go



Foldable design



- 19.8% Highly efficient Monocrystalline Solar Cell
- 48W Solar Panel
- Designed to be portable and withstand outdoor environment
- Excellent low light capabilities
- Working temperature -20° to 70°C
- Foldable design
- IP65 Rated
- Maximum portability and perfect for your when your searchlight or floodlight needs a quick recharge.

Dual Recharging Outlets:



8.4V + 16.8V DC + USB 5

Dimensions:

- Foldable size: 306mm x 309mm
- Open size: 1197mm x 309 x 3mm

Product code: SPSOLARPANEL

## Compatible NightSearcher products:



Environmentally Friendly  
= 100% Energy Saving

- ETFE Lamination increases light absorption by 5%
- Mono C-si Solar cells with 20% conversion efficiency
- Double Layers of EVA ensure the long life-span

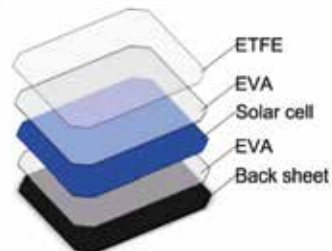

Solaris Pro and Solaris Pro-x  
Floodlight P8



Solaris Duo 40K  
Floodlight P16



ProStar & ProStar Lite  
Searchlight P56



Panther x HP  
Searchlight P59



# New 15m, 25m or 50m LED Rope Lights

The Ultimate On-Site Lighting System, Ensuring your Work Place is Safely Lit and Secure



SITE LIGHTS

1000lm per metre

110V or 230V or 240V

IP65

- 1,000 lumens per metre
- Enclosed in a clear flexible plastic sheath
- Can be reused or relocated
- Simple plug and play system
- Suitable for indoor or outdoor use
- Reduces risks from slips, trips, and other hazards



15 metres  
15,000 Lumens

25 metres  
25,000 Lumens

50 metres  
25,000 Lumens



Multiple plug options

Link multiple lights together

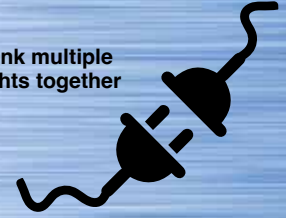

Side by side LEDs



Ideal for use in areas where access and egress need to be illuminated

3 models available:

	15 metres	25 metres	50 metres
	15,000 Lumens	25,000 Lumens	50,000 Lumens
	120° degree beam angle		
	110V or 230V or 240V		
MODE	High		
	IP65 (depending on plug attachment)		
	3kg	4kg	7kg
CODE	NSRL15	NSRL25	NSRL50

Supplied on a reel and mounting clips



CAN BE POWERED BY  
**GENZERO** P32  
BATTERY POWER GENERATORS



Scan for multi-language information

# New Lunar Star 28K

High Energy Efficient Site Light with 360° Illumination



- Floor standing
- Hanging light
- Tripod mountable



Extend to 2.6m



- ☀️ 28,000lm
- 🔦 360° Beam
- ⚡ 110V or 240V
- ☁️ IP65 | IK08

- Mains or generator powered including GenZero battery generators
- Fast, safe, one person deployment
- 360° illumination
- Fitted with 14640 spigot
- Optional 2.6m winch tripod
- Easy to store and transport
- Indoor or outdoor use
- Inside cable storage

☀️	28,000 Lumens
🔦	360° beam
⚡	110V or 240V
MODE	High
☁️	IP65 IK08
↕️	820 x 265mm Ø
📏	8.6kg
CODE	NSLUNARSTAR28K



CAN BE POWERED BY  
**GENZERO** P32  
BATTERY POWER GENERATORS

Supplied with 5m cable, protective light head carry bag and hanging mount

**Optional Accessories:**

Tripod: SPTRIOPOD2.6

14 Metre extension lead: SPCABLE14M



Scan for multi-language information



Tripod mountable check optional accessories for more details



# New Lunar Star 40K

High Energy Efficient Site Light with Multi-directional Rotation



SITE LIGHTS



**Sky Hook**  
Ideal for hanging the light head from scaffolding

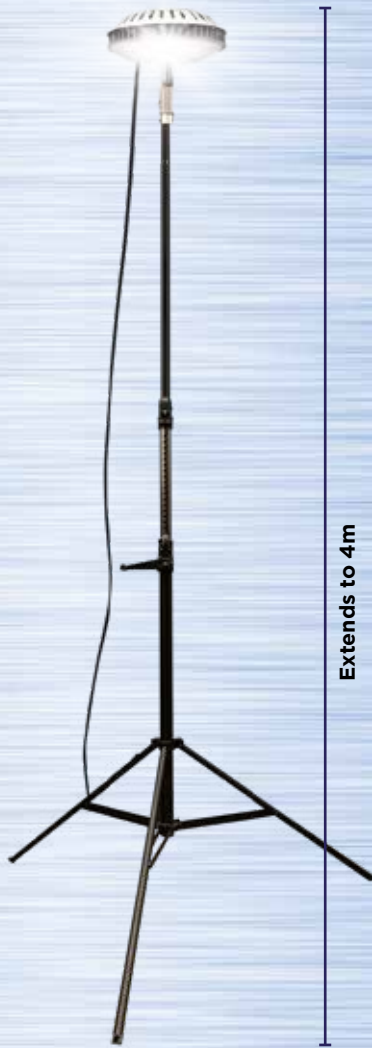
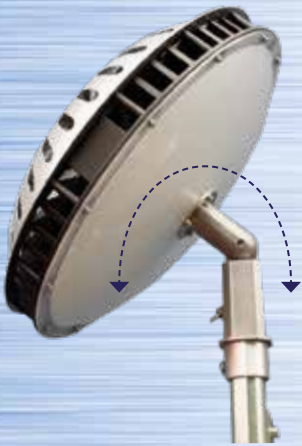

Extends to 4m

- 40,000lm
- 360° Beam
- 110v or 240V
- IP65 | IK08



- Mains or generator powered including GenZero battery generators
- Fast, safe, one person deployment
- Lightweight only 7.8kg
- Fitted with 14640 spigot
- Optional 4m winch tripod
- Easy to store and transport
- Indoor or outdoor use

	40,000 Lumens
	360 Degree beam
	110V or 240V
MODE	High
	IP65 IK08
	200 x 400mm Ø
	7.8kg
CODE	NSLUNARSTAR40K



CAN BE POWERED BY  
**GENZERO** P32  
BATTERY POWER GENERATORS

Supplied with 5m cable, protective light head carry bag and sky hook

**Optional Accessories:**

- Tripod: SPTRIOPOD4
- 14 Metre extension lead: SPCABLE14M



**Winch tripod**  
Safely raise the light head up to 4 metres



Tripod mountable check optional accessories for more details



# LinkStar Kits | EcoStar

Linkable Site Floodlights Designed for Industrial Applications



Single light head with 2.2m tripod stand

Double light head with 2.2m tripod stand and T-Bar bracket



Slim Design

### Choose Voltage:

110V or 240V



### Choose:

Single or double light head

### Choose Lumens:

3,600lm (30W)

6,000lm (50W)

12,000lm (100W)

- 110V or 240V AC 50/60Hz
- Linkable floodlights
- 120° beam angle
- Adjustable brackets
- Strong die-cast aluminium casing with stainless steel fitting
- Designed for industrial applications
- Toughened glass lens
- Light head can also be bought separately

### 110V LinkStar Example:

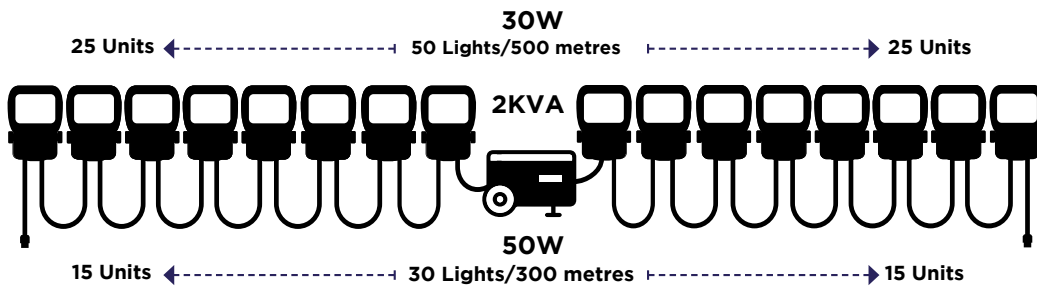

CAN BE POWERED BY  
**GENZERO** P32  
BATTERY POWER GENERATORS

### LinkStar Kits

3 Models available:

	LinkStar 30W	LinkStar 50W	LinkStar 50W
	1 head - 3,600lm 2 heads - 7,200lm	1 head - 6,000lm 2 heads - 12,000lm	1 head - 12,000lm 2 heads - 24,000lm
	110V or 240V		
MODE	High		
	IP65		
CODE	NSLINKSTAR30-KIT NSLINKSTAR30TWIN-KIT	NSLINKSTAR50-KIT NSLINKSTAR50TWIN-KIT	NSLINKSTAR100-KIT NSLINKSTAR100TWIN-KIT

### LinkStar Light Heads

3 Models available:

	LinkStar 30W	LinkStar 50W	LinkStar 50W
	3,600lm	6,000lm	12,000lm
	110V		
MODE	High		
	IP65		
CODE	NSLINKSTAR30	NSLINKSTAR50	NSLINKSTAR100

Supplied with 2.2m swing legged tripod stand and T-Bar Bracket (Twin heads)

### Optional Accessories:

14 Metre extension lead: SPCABLE14M

Scaffold Bracket: SPSCAFFOLDBRACKET



Scaffold bracket



Scan for multi-language information



# Festoon Lights

110V • 10 Lamps • 22 Metres • Fully Encapsulated



SITE LIGHTS



Fitted with 16A 110V CEE Plug

660lm each

110V

IP44

- 10 x 660 lumen, 110V LED lights spaced every 2 metres
- Low heat output - Saves 80% electrical power
- Highly robust polycarbonate lenses and body with handy loops for fixing with cable ties.
- 22 metres 2.0mm yellow arctic grade cable with 16A 110V CEE plug
- Multiple festoons can be linked to form a longer light chain via a junction box
- Fully insulated for indoor and outdoors

	660 Lumens per lamp
	110V AC 16A
MODE	High
	IP44
	22 metres
	2.14kg
CODE	NSFESTOON22M8W

Supplied with 22 Metre 2 x 75mm yellow arctic grade cable with 16A 110V CEE Plug

**Optional Accessories:**  
14 Metre extension lead: SPCABLE14M



CAN BE POWERED BY  
**GENZERO** P32  
BATTERY POWER GENERATORS

Scan for multi-language information



# EcoStar Pro Floodlights

Industrial Floodlights, Low Energy Consumption and Extremely Durable Aluminium



 110V or 240V

 IP65

**Choose:**

Single or double light head



**Choose Lumens:**

 6,000lm (50W)

 12,000lm (100W)

- Robust aluminium casing
- 120° beam angle
- Adjustable bracket
- Can operate on power sources between 85V-265V AC 50-60Hz
- Low heat emission = with no cool down required before storage
- Designed for industrial applications
- Toughened glass lens
- 0.5 metre cable
- High performance heat sink

2 model available:

	EcoStar Pro 50W	EcoStar Pro 100W
	1 head - 6,000 lumens	1 head - 12,000 lumens
	110V or 240V	
<b>MODE</b>	High	
	IP65	
<b>CODE</b>	NSESPRO50	NSESPRO100



**Optional Scaffold bracket**  
SPSCAFFOLDBRACKET



Scan for multi-language information

50 [www.nightsearcher.co.uk](http://www.nightsearcher.co.uk)





# FastStar Security lights

Slim Design Security Light - Fast and Easy Installation



- 800-4000lm
- 10-30m Beam
- 220V-240V
- IP65

- Designed for fast and simple installation
- Tough aluminium housing & tempered glass
- Modern slimline compact design
- Perfect for home and security related applications
- Anti-glare cover
- 6000K cool white colour temperature
- No heat
- Supplied with 30cm cable

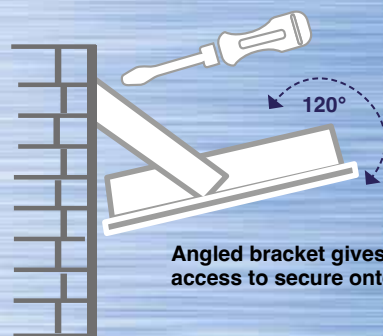

## PIR Floodlights

12 metre motion detection • Day and night auto sensor

3 model available:

	FastStar 10W	FastStar 30W	FastStar 50W
	800 lumens	2400 lumens	4000 lumens
	10m beam	20m beam	30m beam
	220V or 240V		
MODE	High		
	IP65		
	113.4 x 127.9x52mm	147.6 x 166.3x56.3mm	166.8 x 188 x 56.3mm
	334g	555g	730g
CODE	NSFASTSTAR10 NSFASTSTAR10PIR	NSFASTSTAR30 NSFASTSTAR30PIR	NSFASTSTAR50 NSFASTSTAR50PIR

Supplied with 30cm cable



Adjustable settings:

- Lux
- Time
- Sensor



2 ways to connect to mains AC supply:  
directly into internal terminal block









or

With the cable provided, into a suitable rated junction box



Up to 90% more efficient than traditional lighting



	<b>Searchlight: 600 Lumens Work Light: 1200 Lumens</b>
	<b>Up to 700m beam</b>
	<b>Searchlight: 4.5 to 25hrs runtime Work Light: 8 to 40hrs runtime</b>
<b>MODE</b>	<b>Searchlight: High   Low   Strobe   Dimmable Work Light: High   Low   Red   Red Flashing   Dimmable</b>
	<b>3.7V 8000mAh, 30Wh</b>
	<b>6hrs charging time</b>
	<b>IP54</b>
	<b>213 x 132 x 106mm</b>
	<b>708g</b>
<b>CODE</b>	<b>NSCOBRA-X</b>

Supplied with Shoulder strap and type C fast charging cable

**Optional Accessories:**  
 UK or EU adaptor: CH-USB-UK/EU  
 Vehicle Charger: CHIC3.7-LI-ION



Scan for multi-language information



**SEE AND BE SEEN!**



**Red emergency flashing mode**



# New Cobra-X

Rechargeable Searchlight and Floodlight in One

Rechargeable Searchlights



-  1200lm
-  700m Beam
-  8 to 40hrs
-  IP54

- Spot beam searchlight with work light
- Red light mode for an emergency
- Hands-free operation when using the work light
- Rechargeable lithium battery
- Tough polypropylene construction,
- 2 metre impact resistant housing
- Supplied with comfortable shoulder strap

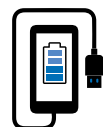

Power bank to charge your phone





2 models available:

	HawkStar	HawkStar-X
	2500 Lumens	4200 Lumens
	Up to 400m	Up to 600m beam
	3.5 to 7.5hrs runtime	4.5 to 9.45hrs runtime
<b>MODE</b>	Narrow   Wide   Boost   Dimmable	
	7.4V 6.6Ah, 48.83Wh	7.4V 10.2Ah, 75.48Wh
	6.5hrs charging time	8hrs charging time
	IP65	IP65
	250 x 125 x 120mm	250 x 125 x 120mm
	1kg	1.1kg
<b>CODE</b>	NSHAWKSTAR	NSHAWKSTAR-X



Supplied with charging cradle and vehicle charger

**Optional Accessories:**

Shoulder strap: SPHAWKSTARSTRAP

AC Charger: CH-8.4V-1.5A



Scan for multi-language information



# HawkStar

Rechargeable Searchlight and Work Light in One

Rechargeable Searchlights



### Dual Optics

- Wide angled flood
- Long distance search
- Or a combination of both beams

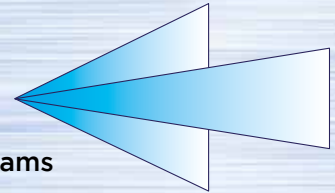









-  4200lm
-  600m Beam
-  4.5 to 9.45hrs
-  IP65

- Dual optics - wide angle flood or long distance search beam
- Multiple brightness levels and dimmable
- Fits securely in charging cradle - Crash tested at 70MPH (112KPH)
- Emergency function - automatically illuminate in the event of a power cut
- Rubberised handle for comfortable non-slip grip
- Wall & vehicle mountable charging cradle with quick release function for fast and easy deployment
- Adjustable stand for hands free use as a work light





2 models available:

	ProStar	ProStar Lite
	10,000 Lumens	
	Up to 1200m beam	
	2 to 25hrs runtime	1.5 to 18hrs runtime
<b>MODE</b>	Narrow   Wide   Boost   Dimmable	
	14.8V 10.2Ah, 150.96Wh	14.8V 7.8Ah, 115.44Wh
	6hrs charging time	
	IP65	
	280x180x120mm	
	1.8kg	1.5kg
<b>CODE</b>	NSPROSTAR	NSPROSTAR-LITE



Supplied with AC adaptor, charging cradle and shoulder strap

**Optional Accessories:**

Vehicle charger: CHIC16.82A-LI-ION

Folding solar panel charger: SPSOLARPANEL



Scan for multi-language information



# ProStar Lite and ProStar

2-in-1 Rechargeable Searchlight and Floodlight



**Dual Optics**  
 - Wide angled flood  
 - Long distance search  
 Or a combination of both beams

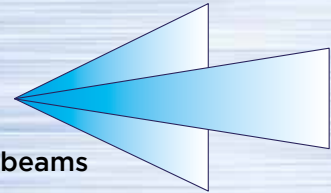

-  10,000lm
-  1200m Beam
-  1.5 to 18hrs
-  IP65



- Dual optics - wide angle flood or long distance search beam
- Multiple brightness levels and dimmable
- Swivel head for directing light where its needed the most
- Rubberised handle for comfortable non-slip grip
- Rubberised bezel for impact protection
- Anti-slip base to give added strength and stability
- Wall and vehicle mountable charging cradle
- Supplied with comfortable shoulder strap











# Trio-550

Lightweight, Rechargeable Searchlight with Emergency Light Function



-  550lm
-  600m Beam
-  3 to 15hrs
-  IP54

- Lightweight design
- Tough durable polycarbonate lens
- Bracket for walls or in vehicles mounting
- Emergency function: Automatically illuminates in the event of a power cut, when on charge
- Water and shock resistant
- USB power bank - charge your device on the go!
- Battery charging indicator
- Supplied with a comfortable shoulder strap

	550 Lumens
	Up to 600m beam
	3 to 15hrs runtime
<b>MODE</b>	High   Low   Flashing
	3.7V 4500mAh, 16.65Wh
	10hrs charging time
	IP54
	193 x 117 x 132mm
	650g
<b>CODE</b>	NSTRIO550Y (Yellow) NSTRIO550 (Grey)

Supplied with wall mount, fast charging USB type C cable, USB 12V-24V car charger, shoulder strap, AC USB mains adaptor



**Emergency Function:**  
Automatically illuminates in the event of a power cut, when on charge



Power bank to charge your phone



Scan for multi-language information



# Panther XHP-X

Searchlight Chosen by Professionals

Rechargeable Searchlights



Hands free use when using built in stand

- 1800lm
- 1000m Beam
- 3 to 8hrs
- IP54

- Parabolic reflector enables maximum distance-to-lumen ratio
- Lightweight design
- Rechargeable lithium battery
- Robust polyethylene construction, impact resistant casing
- Unique deep-dish reflector
- Adjustable stand
- Battery charging indicator
- Supplied with a comfortable shoulder strap

	1800 Lumens
	Up to 1000m beam
	3 to 8hrs runtime
<b>MODE</b>	High   Low   Flashing
	7.4V 4.4Ah, 32.56Wh
	9hrs charging time
	IP54
	260 x 150 x 180mm
	1kg
<b>CODE</b>	NSPANTHERXHP-X Cat No: 0111/108311

Supplied with AC charger, adjustable stand and shoulder strap

**Optional Accessories:**

Vehicle charger: CHIC16.82A-LI-ION  
AC Charger: CH-8.4V-1.5A

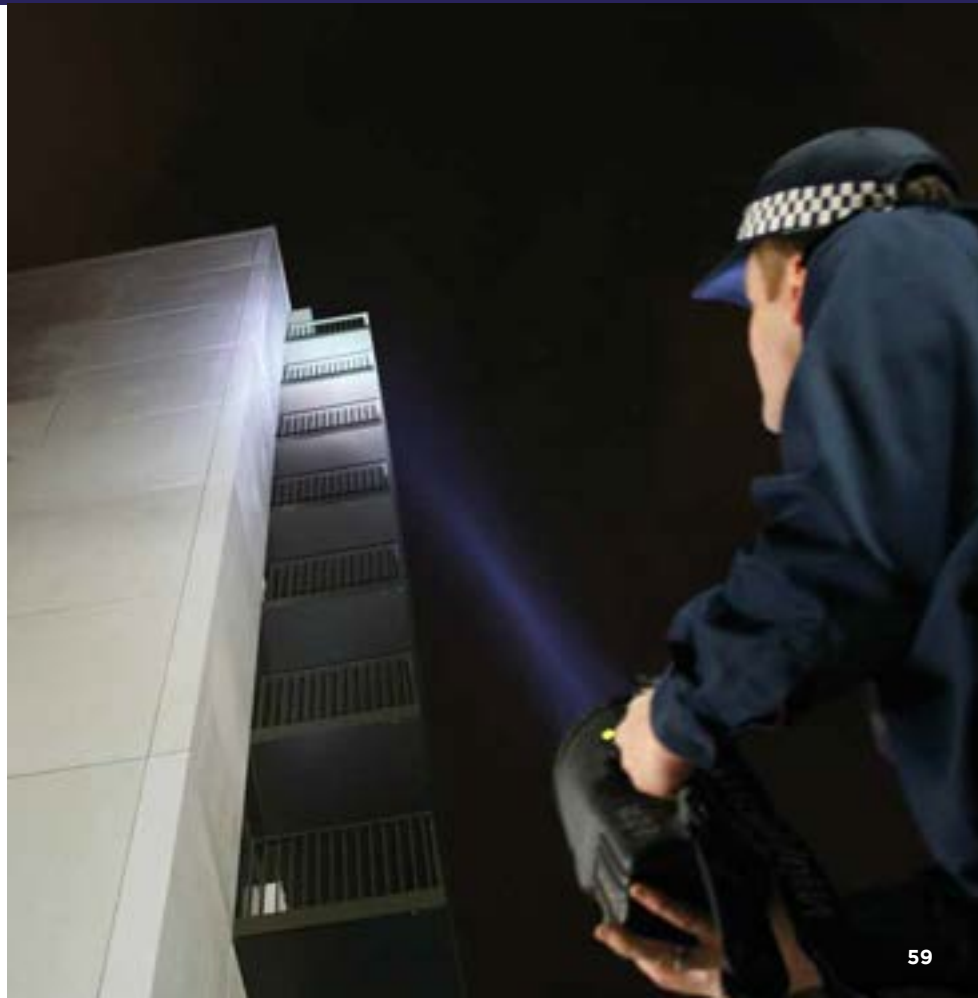









# Trigger Pro

Long Distance Targeted Beam



-  **1300lm**
-  **750m Beam**
-  **3.5 to 12hrs**
-  **IPX4**

- One hand trigger operation
- High impact resistant casing
- Unique deep-dish reflector
- Rechargeable lithium battery
- Rubberised handle for comfortable grip
- Robust polycarbonate construction
- Battery status and charging Indicator

	<b>1300 Lumens</b>
	<b>Up to 750m beam</b>
	<b>3.25 to 12hrs runtime</b>
<b>MODE</b>	<b>High   Low   Strobe</b>
	<b>3.7V 3600mAh</b>
	<b>5hrs charging time</b>
	<b>IPX4</b>
	<b>173 x 176 x 86mm</b>
	<b>570g</b>
<b>CODE</b>	<b>NSTRIGGER-PRO Cat No: 0111/113529</b>

Supplied with wrist strap, micro USB cable, 12V vehicle charger

**Optional Accessories:**  
UK or EU adaptor: CH-USB-UK/EU



Scan for multi-language information



# Searchlight 900

Deep dish Reflector Giving Maximum Distance to Lumen Ratio for a Bright Spot Beam



- 900lm
- 500m Beam
- 1.5 to 5hrs
- IP44

- Robust polypropylene plastic housing
- Two position handle
- Pistol handle
- Rechargeable lithium battery
- Adjustable stand
- USB power bank - charge on the go!
- Storage for charging cable

	900 Lumens
	Up to 500m beam
	1.5 to 5hrs runtime
<b>MODE</b>	High   Low   Flashing
	3.7V 2400mAh, 9Wh, Li-ion
	7hrs charging time
	IP44
	123x158x170mm
	530g
<b>CODE</b>	NSSL900

Supplied with AC Charger and vehicle charger



Power bank to charge your phone



Rechargeable Searchlights



# Searchlight 1600

Powerful Spot beam and Amber Flashing Emergency Mode



- 1600lm
- 1000m Beam
- 3 to 120hrs
- IP44

- Deep-dish reflector giving the maximum distance-to-lumen ratio for a bright spot beam
- Amber flashlight for emergency or signalling purposes
- Robust polycarbonate construction
- Rechargeable lithium battery
- 3-position adjustable handle
- Adjustable stand

	1600 Lumens
	Up to 1000m beam
	3 to 120hrs runtime
<b>MODE</b>	High   Amber flashing
	7.4V 4400mAh, 33Wh, Li-ion
	6hrs charging time
	IP44
	226x165x179mm
	1.03kg
<b>CODE</b>	NSSL1600

Supplied with AC Charger and vehicle charger



Power bank to charge your phone



# PROFESSIONAL FLASHLIGHTS

Ideal for all Rail, Security, Emergency Services, Scenes of Crime, Search and Rescue Sectors

	50mm	100mm	150mm	200mm	250mm	300mm
<b>KEYSTAR</b> 300 Lumens 110m Beam						
<b>EXPLORER MINI</b> 400 Lumens 125m Beam						
<b>EXPLORER CX1000</b> 1000 Lumens 250m Beam						
<b>EXPLORER TWISTER</b> 400 Lumens 90m Beam						
<b>EXPLORER-1200</b> 1200 Lumens 650m Beam						
<b>EXPLORER XPL-C</b> 1100 Lumens 600m Beam						
<b>ZOOM 500</b> 500 Lumens 285m Beam						
<b>ZOOM 600R</b> 600 Lumens 250m Beam						
<b>ZOOM 1000R</b> 1000 Lumens 500m Beam						
<b>MINI MAGNUM</b> 2000 Lumens 400m Beam						
<b>MAGNUM 3000</b> 3000 Lumens 500m Beam						
<b>MAGNUM-1100</b> 1100 Lumens 1100m Beam						<b>Narrow beam</b>
<b>MAGNUM-11600</b> 11600 Lumens 525m Beam						<b>Wide beam</b>



# KeyStar

Searchlight Performance For Your Keychain

Professional Flashlights



Battery status indicator light



Fits on your key ring

- 300lm
- 110m Beam
- 17hrs

- Compact and powerful
- Lightweight and durable
- Easily fits in your backpack, handbag or carry in your pocket
- Rechargeable lithium battery
- Light mode button safety lock
- Dimmable and brightness memory function

	300 Lumens
	Up to 110m beam
	17hrs runtime
<b>MODE</b>	High   Dimmable
	3.7V 600mAh, 3Wh
	4hrs charging time
	IPX7
	67 x 34 x 135mm
	29g
<b>CODE</b>	NSKEYSTAR

Supplied with USB charging cable

**Optional Accessories:**

Vehicle charger: CHIC3.7-L-ION  
 AC adaptor UK/EU: CH-USB-UK/EU

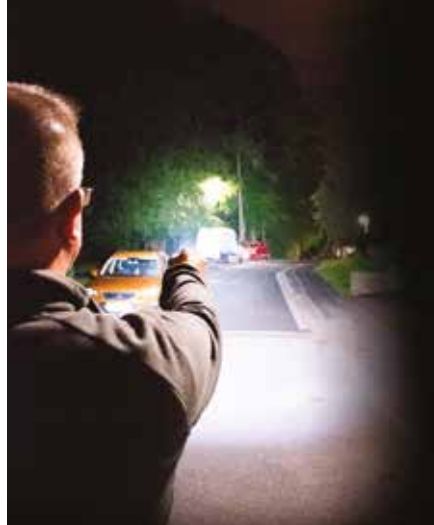

Scan for multi-language information

# Magnum 11600

Ultra-Powerful, Professional, Rechargeable Flashlight with Wide Angled Beam



Rotational light mode dial and transportation lock



- 11600lm
- 525m Beam
- 3 to 54hrs
- IP67

- Ultra wide flood beam
- Rechargeable lithium battery
- Knurled body for secure grip
- Type III hard anodised aluminium housing
- Comfortable shoulder strap
- Battery status indicator

	11600 Lumens
	Up to 525m beam
	3 to 54hrs runtime
<b>MODE</b>	Boost   High   Medium   Low   Eco   Flashing
	7.4V 7800mAh, 58Wh
	9hrs charging time
	IP67
	273 x 95mm ø
	1.235kg
<b>CODE</b>	NSMAGNUM11600

Supplied with mains charger, shoulder strap and carry case

**Optional Accessories:**

Mains charger: CH12V-2A

Vehicle charger: CHICMAGNUM

YouTube



# Magnum 1100

Super Bright and Ideal for Searchlight and Lighting up a Precise Target



Transportation switch lock



- 1100lm
- 1100m Beam
- 1.5 to 26hrs
- IP67

- Longest distance spot beam
- Deep dish parabolic reflector
- Rechargeable lithium battery
- Knurled body for secure grip
- Type III hard anodised aluminium housing
- Comfortable shoulder strap
- Battery status indicator

	1100 Lumens
	Up to 1100m beam
	1.5 to 26hrs runtime
<b>MODE</b>	Boost   High   Medium   Low   Flashing
	7.4V 2600mAh, 20Wh (supplied) or 3 x 1.5V Type C Alkaline batteries
	6hrs charging time
	IP67
	265 x 90mm ø
	835g
<b>CODE</b>	NSMAGNUM1100

Supplied with mains charger, shoulder strap and carry case.

**Optional Accessories:**

Mains charger: CH-MAGNUM-1100-UK

Vehicle charger: CHICMAGNUM

Holster: ACS-D-HOLSTERS

YouTube





# Magnum 3000

Rechargeable, Robust and Reliable Flashlight with Wide Angled Beam



Transportation switch lock



	3000 Lumens
	Up to 500m beam
	1.5 to 25hrs runtime
<b>MODE</b>	Boost   High   Medium   Low   Flashing
	3.7V 5000mAh, 15Wh
	6hrs charging time
	IP67
	62 x 172mm ø
	440g
<b>CODE</b>	NSMAGNUM3000

Supplied with wrist strap, Li-ion battery, AC mains charger and carry case

**Optional Accessories:**  
 Vehicle charger: CHICMAGNUM  
 Holster: ACS-D-HOLSTERS

YouTube



3000lm

500 Beam

1.5 to 25hrs

IP67

- Wide angled beam
- Rechargeable lithium battery
- Knurled body for secure grip
- Type III hard anodised aluminium housing
- Heavy duty wrist strap
- IP67 - Waterproof design
- Battery status indicator



# Mini Magnum

Compact, High Powered Rechargeable Flashlight with Wide Angled Beam



Removable Li-ion battery

Transportation switch lock



	2000 Lumens
	Up to 400m beam
	2 to 57hrs runtime
<b>MODE</b>	Boost   High   Medium   Low   Flashing
	3.7V 5000mAh, 19Wh
	6hrs charging time
	IP68
	158 x 50mm ø
	320g
<b>CODE</b>	NSMINI-MAGNUM

Supplied with USB rechargeable Li-ion battery, charging cable and wrist strap

**Optional Accessories:**  
 Vehicle charger: CHIC3.7-L-ION  
 Holster: ACS-C-HOLSTERS

YouTube



2000lm

400 Beam

2 to 57hrs

IP68

- Wide angled beam
- High capacity 5000mAh Li-ion battery
- Knurled body for secure grip
- Type III hard anodised aluminium housing
- Heavy duty wrist strap
- IP68 - Waterproof design
- Battery status indicator



# New Explorer Twister

Twist from Straight Angle to Right Angle, Rechargeable Flashlight



Twist anti-clockwise to rotate head to 90°

Magnetic USB charger with green/red charging indicator light

- 400lm
- 90m Beam
- 1 to 3hrs
- IPX4

- Adjustable flashlight with right angled torch
- Quick charge, magnetic connection
- Can be used hands free
- Rechargeable lithium battery
- Integrated pocket / belt clip
- Compact and tough aluminium construction
- Strong magnetic base

	400 Lumens
	Up to 90m beam
	1 to 3hrs runtime
<b>MODE</b>	High   Low
	3.7V 750mAh, 3Wh
	4hrs charging time
	IPX4   IK07
	120 x 21mm ø
	86g
<b>CODE</b>	NSEXPLORERTWISTER



Supplied with magnetic fast charging USB type C cable

**Optional Accessories:**

Vehicle charger: CHIC3.7-L-ION

UK or EU adaptor: CH-USB-UK/EU



# New Explorer CX1000 | Explorer Mini

Compact, High Powered Rechargeable Flashlight



Battery status indicator



Charging socket protector

- 1000lm
- 230m Beam
- 4 to 18hrs
- IP67

- Compact size
- Rechargeable lithium battery
- Integrated pocket / belt clip
- Ideal for illuminating precise target
- Type III hard anodised aluminium housing
- Knurled body for secure grip
- Tail cap switch - designed for tactical use

	Explorer CX1000	Explorer Mini
	1000 Lumens	400 Lumens
	Up to 250m beam	Up to 125m beam
	4 to 18hrs runtime	1.5 to 14hrs runtime
<b>MODE</b>	High   Medium   Low	High   Medium   Low Flashing
	3.7V 2600mAh 18650, 7Wh	3.7V 750mAh, 3Wh
	6hrs charging time	2hrs charging time
	IP67	IP67
	133 x 30mm ø	119 x 25mm ø
	149g	85g
<b>CODE</b>	NSEXPLORER-CX1000	NSEXPLORERMINI

Supplied with USB charging cable and wrist strap

**Optional Accessories:**

Vehicle charger: CHIC3.7-L-ION

UK or EU adaptor: CH-USB-UK/EU





# Upgraded Explorer 1200

Ultra-Lightweight, Professional Flashlight with a Compact Design



Through switch battery status + charging indicator



1200lm

650 Beam

2.5 to 63hrs

IPX7

- Powerful long spot beam
- Ultra lightweight design
- Rechargeable lithium battery
- Knurled body for secure grip
- Type III hard anodised aluminium housing
- 2 hidden light modes: Strobe / SOS
- Tail cap switch - designed for tactical use

	1200
	Up to 650m beam
	2.5 to 63hrs runtime
<b>MODE</b>	High   Medium   Low   Eco   Flashing   SOS
	3.7V 2600mAh, 9.62Wh
	6hrs charging time
	IPX7
	165 x 35mm ø
	211g
<b>CODE</b>	NSEXPLORER1200



Supplied with Type C USB charging cable

**Optional Accessories:**

Vehicle charger: CHIC3.7-L-ION

UK or EU adaptor: CH-USB-UK/EU

Holster: SP-MEGAZOOM-HOLSTER, SP-HOLSTER



# Upgraded Explorer XPL-C

Heavy Duty, Rechargeable LED Flashlight with USB-C Port and Charging Cradle



Supplied with red cone for signalling



Supplied with a charging cradle - convenient and always ready fully charged



1100lm

600 Beam

1 to 12hrs

IP65

- Powerful long spot beam
- Wall or vehicle mounted charging cradle
- In the event of a power cut 6 white LEDs will illuminate automatically
- Type III hard anodised aluminium housing
- Rechargeable lithium battery
- Knurled body for secure grip
- Tail cap tactical switch

	1100 Lumens
	Up to 600m beam
	1 to 12hrs runtime
<b>MODE</b>	High   Medium   Low   Flashing   SOS
	3.7V 2600mAh, 10Wh
	6hrs charging time
	IP65
	Flashlight: 193 x 44mm ø
	280g
<b>CODE</b>	NSEXPLORER-XPL-C



Supplied with Li-ion battery, charging cradle, red cones and Type C USB charging cable

**Optional Accessories:**

Yellow cone: SPEXP-XML-CY

Holster: SP-HOLSTER

UK or EU adaptor: CH-USB-UK/EU



# Spot to Flood - Zoom Flashlight Range



Pull bezel to zoom from spot to flood



Zoom Focus Beam:  
Long Distance Spot Beam  
+ Wide Flood Beam

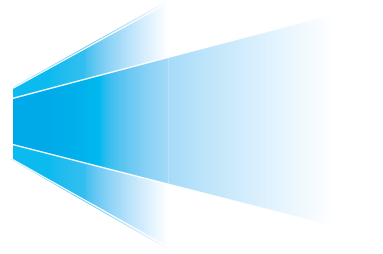

FLOOD BEAM



SPOT BEAM



## New Zoom 600R

Rechargeable Spot to Flood Zoom Flashlight with Wall / Vehicle Mount Charging Base



Wall/vehicle mounting slots

Charging base with indicator light

	600 Lumens
	Up to 250m beam
	1.5 to 15hrs runtime
<b>MODE</b>	High   Low   Medium
	3.7V 2600mAh, 10Wh
	4hrs charging time
	IPX4   IK07
	135 x 31mm ø
	200g
<b>CODE</b>	NSEXPLORER-600R



Supplied with fast charging USB Type C cable and charging base

**Optional Accessories:**

Vehicle charger: CHIC3.7-L-ION  
Holster: SP-MEGAZOOM-HOLSTER  
UK or EU adaptor: CH-USB-UK/EU



600lm

250m Beam

1.5 to 15hrs

IPX4

- Compact size
- Rechargeable lithium battery
- Integrated pocket / belt clip
- Ideal for illuminating precise target
- Type III hard anodised aluminium housing
- Knurled body for secure grip
- Tail cap switch - designed for tactical use



# Zoom 500

4AA Battery Powered Tactical LED Flashlight with Spot-to-Flood Zoom



Optional signalling cones

	500 Lumens
	Up to 285m beam
	1 to 45hrs runtime
<b>MODE</b>	Boost   High   Medium   Low   Flashing
	4 x AA Alkaline battery
	IP66
	141 x 29mm ø
	169g
<b>CODE</b>	NSEXZOOM500



Supplied with 4 x AA Alkaline battery and wrist strap

**Optional Accessories:**

Red cone: SPEXP-XML-CR

Yellow cone: SPEXP-XML-CY

Holster: SP-MEGAZOOM-HOLSTER, SP-HOLSTER



500lm

- Fully adjustable spot-to-flood beam
- Ultra lightweight design
- Rechargeable lithium battery
- Knurled body for secure grip
- Type III hard anodised aluminium housing
- Tail cap switch - designed for tactical use

285 Beam

1 to 45hrs

IP66

# Upgraded Zoom 1000R

Rechargeable Tactical LED Flashlight with Spot-to-Flood Zoom



Protected USB charge port with battery status indicator

	1000 Lumens
	Up to 500m beam
	4 to 50hrs runtime
<b>MODE</b>	Boost   High   Medium   Low   Flashing
	3.7V 2600mAh Li-ion
	4hrs charging time
	IP66
	141 x 29mm
	169g
<b>CODE</b>	NSEXZOOM1000R



Supplied with wrist strap and Type C cable charging cable

**Optional Accessories:**

Yellow cone: SPEXP-XML-CY

AC adaptor UK/EU: CH-USB-UK/EU

Holster: SP-MEGAZOOM-HOLSTER, SP-HOLSTER

Vehicle charger: CHIC3.7-LION

UK or EU adaptor: CH-USB-UK/EU



1000lm

- Fully adjustable spot-to-flood beam
- Ultra lightweight design
- Rechargeable lithium battery
- Knurled body for secure grip
- Type III hard anodised aluminium housing
- Tail cap switch - designed for tactical use

500 Beam

4 to 50hrs

IP66

# UV395

Lightweight, Battery-Powered UV Flashlight Designed for Detecting Counterfeit Money and Documents



	395nm Wave length
	3.5hrs runtime
<b>MODE</b>	High
	2 x CR123A batteries (not supplied)
	IP66
	132 x 33.5mm ø
	113g
<b>CODE</b>	NSUVLED395 CAT/PAD:0111/1123331



**Optional Accessories:**

Holster: SP-MEGAZOOM-HOLSTER, SP-HOLSTER

- 395nm
- 3.5hrs
- IP66

- Compact and lightweight design
- Rechargeable lithium battery
- Integrated pocket / belt clip
- Ideal for illuminating precise target
- Type III hard anodised aluminium housing
- Knurled body for secure grip
- Tail cap switch - designed for tactical use



# UV365

Heavy-duty UV Flashlight Designed for Detecting Counterfeit Money and Documents



Supplied with 12V-24V AC charger, vehicle charger, 2 x rechargeable batteries, USB charging lead, and 2 x O-rings

	365nm Wave length, 1,030,000uW
	Up to 30m
	3hrs runtime
<b>MODE</b>	High
	2 x 18650 Li-ion batteries (Not Supplied)
	4hrs charging time
	IP65
	153 x 40mm ø
	185g
<b>CODE</b>	NSUVLED365



**Optional Accessories:**

Holster: SP-MEGAZOOM-HOLSTER, SP-HOLSTER

- 365nm
- 30m Beam
- 3hrs
- IP65

- Heavy duty and compact design
- Rechargeable lithium battery
- Integrated pocket / belt clip
- Ideal for illuminating precise target
- Type III hard anodised aluminium housing
- Knurled body for secure grip
- Tail cap switch - designed for tactical use





# New UV365-MAX

Rechargeable UV Flashlight Specifically Designed for Security, Inspection and Crime Scene Investigations



	365nm Wave length, 3,640,000 uW
	Up to 100m
	2hrs runtime
<b>MODE</b>	High   Low
	1 x 18650 / 26650 Li-ion 8Wh
	165 x 45mm ø
	210g
<b>CODE</b>	NSUV365-MAX



UV Forensic Flashlights

Supplied with USB charger, charging cable, Li-ion rechargeable battery and UV protective glasses

**Optional Accessories:**  
Holster: ACS-C-HOLSTERS



- 365nm**
  - 100m Beam**
  - 2hrs**
- 365nm Wavelength, 3,640,000 uW
  - Compact and lightweight design
  - Built-in cooling fan
  - Rechargeable lithium battery
  - Knurled body for secure grip
  - Type III hard anodised aluminium housing

# New UV365-2AA

High Powered UV Flashlight Specifically Designed for Forensic Applications and Crime Investigation



	365nm Wave length, 980,000uW
	Up to 100m
	2hrs runtime
<b>MODE</b>	High
	1 x AA Alkaline batteries
	132x33.5mm ø
	29 x 24.5 x1 52mm
	118g
<b>CODE</b>	NSUV365-2AA



Supplied with 1 x AA Alkaline battery

**Optional Accessories:**  
Holster: SP-MEGA ZOOM-HOLSTER



- 365nm**
  - 100m Beam**
  - 2hrs**
- Compact size
  - Powered by 1 x AA Alkaline batteries
  - Integrated pocket / belt clip
  - Ideal for illuminating precise target
  - Type III hard anodised aluminium housing
  - Knurled body for secure grip
  - Tail cap switch - designed for tactical use

# Spot to Flood - Zoom Head Torch Range

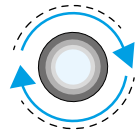

**Zoom Focus Beam**  
Long Distance Spot Beam  
To  
Wide Flood Beam

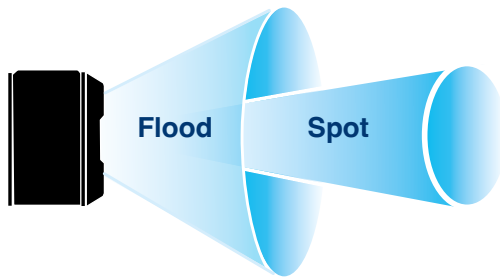

**FLOOD BEAM**



**SPOT BEAM**

## New Zoom 700 + 700R Adjustable Spot to Flood Zoom Head Torch



### Two models available:

#### Zoom 700

Supplied with 3 x AAA Alkaline batteries

#### Zoom 700R

Supplied with a removable Lithium battery pack



OR



700lm

200m Beam

1.5 to 25hrs

IP64

- Wide flood beam + long distance Spot beam
- Hybrid power supply - rechargeable lithium battery and disposable batteries
- Compact and lightweight design
- Warm white diffused beam for close up work
- 90° beam angle adjustment
- Adjustable non-slip head straps

	Zoom 700	Zoom 700R
	700 Lumens	
	Up to 200m beam	
	1.5 to 25hrs runtime	
<b>MODE</b>	High   Medium   Low   Warm White	
	3 x AAA Alkaline batteries	3.7V 2600mAh, 10Wh Li-ion
	4.5hrs charging time	-
	IP64   IK08	
	65 x 45 x 45mm	
	95g	
<b>CODE</b>	NSHTZOOM700	NSHTZOOM700R

Supplied with USB Charging cable and lithium battery (Zoom 700R) 3 x AAA batteries (Zoom 700)

#### Optional Accessories:

Spare battery: BA3.7X800MAH

Helmet clips: SPPCLIPS,

AC Adaptor UK or EU: CH-USB-UK/EU

12/24V Vehicle charger: CHIC3.7-LI-ION

YouTube



Scan for multi-language information





# New Zoom 780EXR

Adjustable Spot to Flood Zoom Head Torch with 10.5 Hours Runtime (High mode)



White rear light

	780 Lumens
	Up to 200m beam
	10.5 to 82hrs runtime
<b>MODE</b>	High   Medium   Low Rear White   Rear White Flashing
	2 x 3.7V 18650 6400mAh Li-ion or 4 x AA Alkaline battery
	IP66
	81 x 59 x 47mm
	351g
<b>CODE</b>	NSHTZOOM780EXR

Supplied with USB charging cable and lithium battery

**Optional Accessories:**

Helmet clips: SPPCLIPS

AC Adaptor UK or EU: CH-USB-UK/EU

12/24V Vehicle charger: CHIC3.7-LI-ION

- 780lm
- 200 Beam
- 10.5 to 82hrs
- IP66

- Fully adjustable spot-to-flood beam
- Ultra lightweight design
- Rechargeable lithium battery
- Knurled body for secure grip
- Type III hard anodised aluminium housing
- Tail cap switch - designed for tactical use

## Hybrid Head Torch

Can be used with the (supplied) Lithium battery pack or 4 x AA Alkaline batteries



# Zoom 1100RX

Rechargeable Spot to Flood Zoom Head Torch with Red Rear Warning Lights



Red rear warning light for your safety

	1100 Lumens
	Up to 300m beam
	2.5 to 42hrs runtime
<b>MODE</b>	Boost   High   Medium   Low   Flashing Rear Red + Flashing
	3.8V 2850mAh, 109Wh or 4 x AA Alkaline batteries
	3.5hrs charging time
	IP66   IK08
	61 x 70 x 63m
	292g
<b>CODE</b>	NSHTZOOM1100RX

Supplied with USB Charging cable and lithium battery

**Optional Accessories:**

Helmet clips: SPPCLIPS

AC Adaptor UK or EU: CH-USB-UK/EU

12/24V Vehicle charger: CHIC3.7-LI-ION

- 1100lm
- 300m Beam
- 2.5 to 42hrs
- IP66

- Wide Flood beam + Long distance Spot beam
- Multiple light modes
- Rear red warning lights
- Charging indicator
- Adjustable non slip head straps
- Removable battery pack with charging indicator
- 90° Beam Angle Adjustment

## Hybrid Head Torch

Can be used with the (supplied) Lithium battery pack or 4 x AA Alkaline batteries







# LightWave 520R

Rechargeable, Spot and Flood beam with On/Off Wave Sensor



-  520lm
-  140m Beam
-  2.5 to 5hrs
-  IP44

- Wide flood beam
- 180° beam angle adjustment
- Adjustable non-slip head straps
- Diffused shadow and glare-free lens
- Battery status indicator
- Quick 3 hours recharge
- Perfect for hands-free operation

	520 Lumens
	Up to 140m beam
	2.5 to 5hrs runtime
<b>MODE</b>	Spot + Flood   Flood   Spot
	3.7V 1800mAh, 7Wh
	3hrs charging time
	IP44   IK08
	65 x 40 x 47mm
	96g
<b>CODE</b>	NSHTLIGHTWAVE520

 **ON/OFF Wave Sensor**

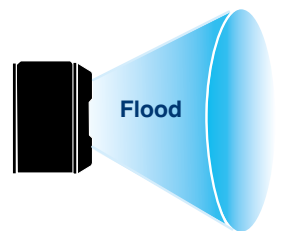

**2 Ways to turn ON+OFF:**  
Manual switch or Wave.

Ideal when hands are dirty, wearing gloves, fishing or climbing

Supplied with  
Fast charging USB type C charging cable

**Optional Accessories:**

Helmet clips: SPPCLIPS,  
AC Adaptor UK or EU: CH-USB-UK/EU  
12/24V Vehicle charger: CHIC3.7-LI-ION

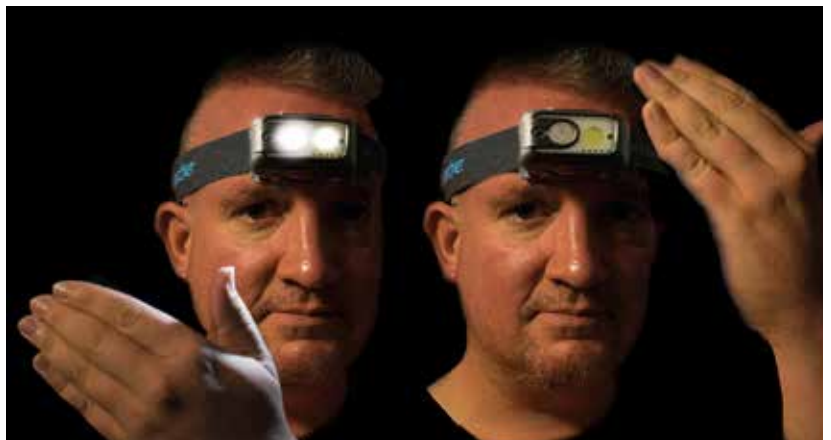

 **YouTube**

Scan for multi-language information



# HT800 and HT800RX

Distance Sensor Automatically Adjusts from Spot to Flood beam

Rechargeable Head Torches



**HT800RX**  
Rear white lights  
Battery charging and status Indicator  
Charge directly in head torch



**HT800**  
Rear warning lights

- 850lm
- 550m Beam
- 2.5 to 50hrs
- IP66

- Distance sensor
- 180° beam angle adjustment
- Light mode memory
- Adjustable non-slip head straps
- Safety Lock: Prevents accidental power loss during storage or transportation
- Diffused side lights for low level lighting
- Optional helmet clip available

	HT800RX Rechargeable	HT800 Non-rechargeable
	800 Lumens	850 Lumens
	Up to 550m beam	Up to 550m beam
	2.5 to 169hrs runtime	2.5 to 50hrs runtime
<b>MODE</b>	Spot + Flood, Flood (Low or High) Spot (Low or High)	Spot + Flood, Flood (Low or High) Spot (Low or High)
	3.7V 2600mAh, 9.62Wh	4 x AA Alkaline battery
	5hrs charging time	-
	IP66	IP66
	46 x 85 x 39mm	46 x 85 x 39mm
	230g	219g
<b>CODE</b>	NSHT800RX Cat No: 0111/120695	NSHT800

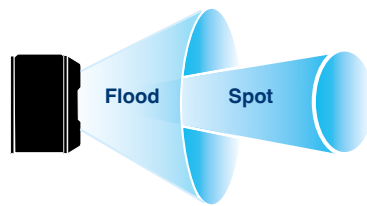

**Distance Sensor:**  
Automatic spot to flood sensor



**DIFFUSED SIDE LIGHTS**

Supplied with  
HT880RX: USB Charging cable and Lithium battery  
HT800: 4 x AA Alkaline Batteries

**Optional Accessories:**  
Spare battery: BA18650-USB  
Helmet clips: SPPCLIPS  
AC Adaptor UK or EU: CH-USB-UK/EU  
12/24V Vehicle charger: CHIC3.7-LI-ION



**FLOOD BEAM**



**SPOT BEAM**

The ATEX certification mark on our SafATEX range of portable and fixed lighting signifies that our equipment has been rigorously tested and is completely safe for use in potentially explosive atmospheres for which they are certificated. Oil, Gas, Petrochemical, Aviation, Marine, Utility sectors and the Emergency Services are all markets sectors where our ATEX products can be used.

Employee safety is crucial for everyone working within these hostile and hazardous environments. Each product within the SafATEX range has been carefully thought out and designed to promote worker safety as well as ease of use. The portable products are designed to be used whilst wearing PPE, such as fire fighter gloves.



**YouTube**  
Scan to see the range in Action

Create a safe, compliant workspace with our selection of portable lighting and fixed light fittings.

## Designed for oil & gas, petrochemical, aviation, marine, mining and utility applications

### Intrinsically Safe Explained

#### Hazardous Area Classification Zone 0, Zone 1, Zone 2

This diagram shows how hazardous area zones may occur in typical circumstances



**Gas Zones**  
0 + 1 + 2

**Flammable**  
gases, vapour  
or liquids

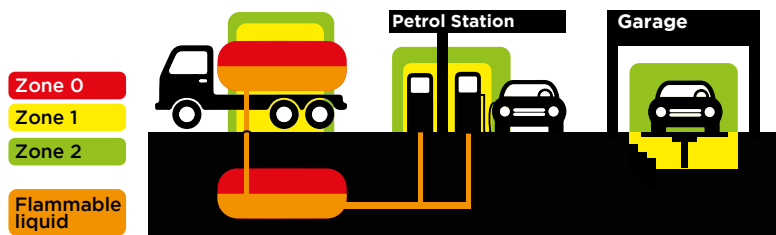

#### Hazardous Area Classification Zone 20, Zone 21, Zone 22

This diagram shows how hazardous area zones may occur in typical circumstances



**Dust Zones**  
Zone 20 + 21 + 22

**Combustible**  
dusts

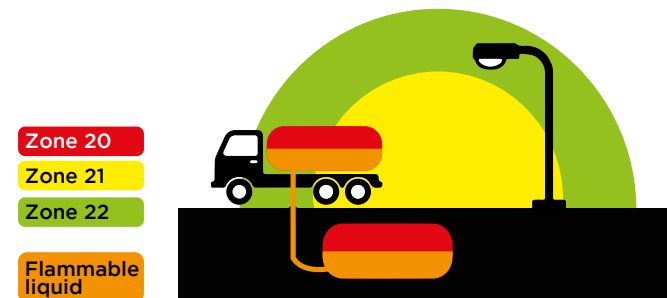

The SafAtex portable lights are trusted by a wide variety of commercial and industrial users, as well as emergency services all over the world.

**ATEX Marking**



CE and UKCA mark denotes manufacturers declaration of product compliance to all relevant EU Directives



Specific mark for Explosion Protection



Equipment Group (Mining)



Equipment Category (Mining)



Not For Use In Mines



Atex Category 1 (Old Zone 0)



Tested for Gases, Vapour and Dust Atmospheres

**ATEX Ex Marking For Explosive Dust Atmospheres**



Explosion Protected Equipment



Intrinsic Safe 'i'



Dust Group



Temperature Classification



Equipment Protection Level



Ingress Protection Level Marking

**ATEX Ex Marking For Explosive Gas Atmospheres**



Explosion Protected Equipment



Intrinsic Safe 'i'



Gas Group



Equipment Protection Level



Gas Group



Temperature Classification



Equipment Protection Level



# SAFATEX Sigma SL 1000

Zone 1 and 21, Rechargeable Searchlight with a Long Spot Beam



GAS ZONE 1    DUST ZONE 21



- 890lm
- 830m Beam
- 8 to 20hrs
- IP68

- Robust aluminum housing with a neoprene rubberised cover for additional protection
- Digital battery status indicator with real-time display
- Rechargeable lithium battery
- Ergonomic handle for easy light mode operation
- Compact size for ease of use in confined spaces and transportation

	890 Lumens
	Up to 830m beam
	8 to 20hrs runtime
<b>MODE</b>	High   Low   Flashing
	22.2 V   2600mAh 6 x 18650 batteries
	8hrs charging time
	IP68
	140 x 67mm Ø
	872g
<b>CODE</b>	SA-SIGMA-RSL1000

CERTIFICATION:



Safatex Lights

Supplied with AC charger and shoulder strap

ATEX Zone 1 & 21 and 2 & 22  
 II 2 G Ex db Ib IIC T6 Gb  
 II 2 D Ex Ib tb IIIC T80°C Db IP68 -20°C <Ta> +55°C  
 ATEX Cert No. TUV 19 ATEX 8442 X  
 IECEx Cert No. IECEx TUR 19.0062X



# SAFATEX Sigma RSL370

Zone 0, Rechargeable Searchlight, with Charging Cradle



GAS ZONE 0    MINING APPROVED



	370 Lumens
	Up to 400m beam
	4 to 30hrs runtime
<b>MODE</b>	High   Medium   Low
	3.7V 1960mAh, Li-ion
	6.5hrs charging time
	IP64
	256 x 136.2 x 170.4mm
	Searchlight: 650g with cradle: 980g
<b>CODE</b>	SA-SIGMA-RSL

CERTIFICATION:



Supplied with shoulder strap and wall charging adlectr

CLASS I DIV 1&2 GRP ABCD, CLASS III  
 TEMP CODE: T4 IP64 FILE NUMBER: 261379  
 ATEX Zone 0 Gas: II 1G Ex ia op is IIC T4 Ga  
 Mining: I M1 Ex ia op is I Ma SIRA 17 ATEX 2195X  
 GAS: Ex ia op is IIC T4, Ga (Zone 0)  
 MINING: Ex ia Ma | IECEx SIR 17.0042X



- 370lm
- 400m Beam
- 4 to 30hrs
- IP64

- Powerful beam from parabolic reflector
- Tough polycarbonate, ABS construction ideal for heavy industrial use
- Wall mountable charging cradle
- Lightweight design
- Rechargeable lithium battery
- Large switch - can be easily operated when wearing gloves
- Battery charging indicator



# SAFATEX Sigma MINI

Zone 0 Head Torch, with Easy Twist On/Off Bezel Switch



GAS ZONE 0



MINING APPROVED



- 140lm
- 86 Beam
- 6hrs
- IP67

- Rotary on/off switch
- Strong ABS housing with durable rubber coating
- Fully adjustable silicone lined headband
- Submersible up to 1 metre for 30 mins
- Safety locking battery compartment
- 90° rotational switch

	140 Lumens
	Up to 86m beam
	6hrs runtime
<b>MODE</b>	High
	3 x AAA batteries (not included)
	IP67
	70 x 60mm Ø
	110g
<b>CODE</b>	SA-SIGMA-HTMINI

Optional Accessories:  
Helmet clips: SPPCLIPS

CLASS I DIV 1&2 GRP ABCD | CLASS II DIV 1&2 GRP EFG  
CLASS III / TEMP CODE: T4 IP67 | FILE NUMBER: E324236

ATEX Zone 0

I M1 Ex ia I Ma | II 1G Ex ia IIC T4 Ga  
DEMKO 15 ATEX 1546X

Gas: Ex ia IIC T4 Ga | Mine: Ex ia I Ma | IECEx UL 15.0086X

CERTIFICATION:



# SAFATEX Sigma PRO

Zone 0 Head Torch, with Large Switch and Powerful 100m Beam



GAS ZONE 0



- 220lm
- 100m Beam
- 5 to 12hrs
- IP67

- Large accessible switch, even when wearing bulky gear such as fire gloves
- Strong ABS housing with durable rubber coating
- Fully adjustable silicone lined headband
- Submersible up to 1 metre for 30 mins
- Safety locking battery compartment
- 90° rotational head

	220 Lumens
	Up to 100m beam
	5 to 12hrs runtime
<b>MODE</b>	High   Low
	3 x AAA batteries (not included)
	IP67
	80 x 50 x 45mm
	143g
<b>CODE</b>	SA-SIGMA-HTPRO

Optional Accessories:  
Helmet clips: SPPCLIPS

CLASS I DIV 1&2 GRP ABCD | CLASS II DIV 1&2 GRP EF  
CLASS III TEMP CODE: T4 IP67 | FILE NUMBER: E324236

ATEX Zone 0 | Gas: II 1G Ex ia IIC T4 IP67  
DEMKO 14 ATEX 1354X

Gas: Ex ia IIC T4 Ga IP67 | IECEx UL 14.0059X

CERTIFICATION:





# SAFATEX Sigma RFL

Zone 1 and 21 Rechargeable Dual Ended Flashlight, with Spot or Flood Beam



Large buttons for easy operation with gloved hand

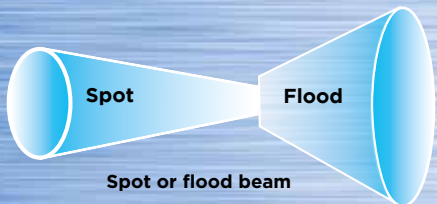

Spot or flood beam

GAS ZONE 1    DUST ZONE 21



- 157lm
- 220m Beam
- 18.5hrs
- IP68

- Compact and lightweight
- High strength aluminium housing
- Easy operation with gloved hands
- Rechargeable lithium battery
- Suitable for heavy industrial use
- Dual ended - front spot light and rear flood light
- Battery charging indicator

	Spot: 157   Flood: 129 Lumens
	Up to 220m   100m beam
	9   18.5hrs runtime
<b>MODE</b>	Spot: High   Low Flood: High   Low   Flashing
	3.7V 2.2Ah, Li-ion
	6hrs charging time
	IP68
	156 x 35mm Ø
	190g
<b>CODE</b>	SA-SIGMA-RFL

CERTIFICATION:



Supplied with wrist strap

ATEX Zone 1 & 21 and 2 & 22  
 II 2 G Ex ib IIC T4 Gb  
 II 2 D Ex ib IIIC T130°C IP68  
 ATEX Certificate NO:  
 TÜV 15 ATEX 7713X



Scan for multi-language information



Rear Light

Spot

Flood

Front Light

# SAFATEX Sigma ZOOM

Zone 0, with Adjustable Spot to Flood Beam



Twist bezel to zoom from spot to flood

GAS ZONE 0    MINING APPROVED



- 235lm
- 116m Beam
- 11 to 36hrs
- IP67

- Adjustable beam - twist head for spot to flood beam making it ideal for both distance and close up work
- Rotate sliding switch between light modes
- Tough polycarbonate housing, rubberised head and grip for durability
- Suitable for heavy industrial use
- Easy operation with gloved hand

	83-235 lumens
	Spot: Up to 116m beam Flood: Up to 26m beam
	11 to 36hrs runtime
<b>MODE</b>	Spot: High   Low Flood: High   Low   Flashing
	4 x AA batteries (not included)
	IP67
	184 x 52mm Ø
	250g
<b>CODE</b>	SA-SIGMA-ZOOM

CERTIFICATION:



Supplied with wrist strap

CLASS I DIV 1&2 GRP ABCD | CLASS II DIV 1&2 GRP EFG  
 CLASS III / TEMP CODE: T4 IP67 | FILE NUMBER: E324236

ATEX ZONE 0 GAS: II 1G Ex ia IIC T4 Ga  
 MINE: I M1 Ex ia I Ma | DEMKO 15 ATEX 1476X  
 GAS: EX ia IIC T4 GA | MINE: Ex ia I Ma | IECEX UL 15.0046X

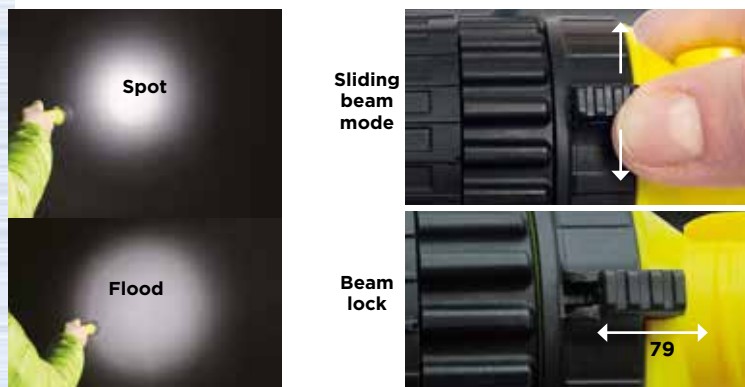

Spot

Sliding beam mode

Flood

Beam lock

# SAFATEX Sigma RA

Zone 0 Right Angled Torch, Used by Fire Fighters Wearing Breathing Apparatus

Rubberised head and grip



Pocket/Belt stainless steel clip

GAS ZONE 0



MINING APPROVED



	325   140 Lumens
	Up to 290m beam
	6.5 to 13hrs
<b>MODE</b>	High   Low
	4 x AA batteries (not included)
	IP54
	183 x 69 x 63mm
	250g
<b>CODE</b>	SA-SIGMA-RA

Supplied with AC charger and wrist strap

CERTIFICATION:



CLASS I DIV 1&2 GRP ABCD | CLASS II DIV 1&2 GRP EFG  
CLASS III TEMP CODE: T4 IP54 | FILE NUMBER: 261379

ATEX Zone 0 Gas: II 1G Ex ia IIC T4 Ga  
MINING: I M1 Ex ia I Ma | Sira 15ATEX2166X  
GAS: Ex ia IIC T4 Ga | MINING: Ex ia Ma  
IECEX SIR 15.0062X



- 325lm
- 290 Beam
- 6.5 to 13hrs
- IP54

- 90° beam allowing chest mounting for hands free operation
- Focus designed to penetrate through smoke
- Large switch is easy to operate even when wearing gloves
- Rubberised head and grips for durability
- Tough polycarbonate housing
- Easily cleaned after use



# SAFATEX Sigma 4AA

Zone 0 Compact Flashlight, with Sliding Mode Switch

Sliding light mode switch



Safety lock to prevent from accidental operation

GAS ZONE 0



	185 Lumens
	Up to 117m beam
	8 to 30hrs
<b>MODE</b>	High   Low   Flashing
	4 x AA batteries (not included)
	IP68
	172 x 47mm Ø
	140g
<b>CODE</b>	SA-SIGMA-4AA

Supplied with wrist strap

Optional Accessories:  
Helmet clips

CLASS I DIV 1&2 GRP ABCD | CLASS II DIV 1&2 GRP EFG  
CLASS III TEMP CODE: T4 | FILE NO: E324236

Gas: II 1 G Ex ia IIC T4 IP68 | DEMKO 13 | ATEX 1205039X  
Gas: Ex ia IIC T4 Ga | IECEX UL13.0060X

CERTIFICATION:



- 185lm
- 117m Beam
- 8 to 30hrs
- IP68

- Flashing mode ideal for signalling
- IP68 Rated
- Rubberised head for extra durability
- Tough polycarbonate housing
- Impact resistant, drop proof up to 1m
- Easy operation with gloved hand
- Can be mounted on a helmet





# SAFATEX Sigma PL

Zone 0 Pocket Sized Light, with a Long 20.5 hours Runtime

Pocket/Belt clip



GAS ZONE 0 MINING APPROVED



	67 Lumens
	Up to 41m beam
	20.5hrs runtime
<b>MODE</b>	High
	2 x AA batteries (not included)
	IP67
	142 x 30 x 26mm
	41g
<b>CODE</b>	SA-SIGMA-PL

CERTIFICATION:



SafateX Lights

Supplied with wrist strap

CLASS I DIV 1&2 GRP ABCD | CLASS II DIV 1&2 GRP EFG  
CLASS III Temp Code T5 IP67 File number: E324236

ATEX Zone 0 Gas: II 1G Ex ia IIC T5 Ga  
Mine: I M1 Ex ia I Ma | DEMKO 16 ATEX 1661X  
Gas: Ex ia IIC T5 Ga Mine: Ex ia I Ma | IECEx UL 16.0015X



67lm

41m Beam

20.5hrs

IP67

- Long run time up to 20.5 hours
- Rubberised head for extra durability
- Tough polycarbonate housing for heavy industrial use
- Easy ON/OFF tail switch, when wearing gloves
- IP67 Submersible up to 1 metre for 30 mins
- Tail cap switch



# SAFATEX Sigma 3C

Zone 0 Large Capacity Battery, with 80 Hours Runtime



Removable clip allowing you to easily attach to overalls, jackets and clip boards



GAS ZONE 0



	150 Lumens
	Up to 248m beam
	42.5 to 80hrs runtime
<b>MODE</b>	High   Low
	3xC Cell batteries (not included)
	IP67
	225 x 60 x 85mm
	190g
<b>CODE</b>	SA-SIGMA-3C

CERTIFICATION:



Optional Accessories:  
Helmet bracket

CLASS I DIV 1 & 2 GRP ABCD | CLASS II DIV 1 & 2 GRP EFG  
CLASS III TEMP CODE: T4 | FILE NO: E61379

ATEX Zone 0 | Gas: II 1G Ex ia IIC T4 | DEMKO 13 ATEX 1112940X  
Gas: Ex ia IIC T4 Ga | IECEx UL 13.0008X



150lm

248m Beam

80hrs

IP67

- Long run time up to 80 hours
- Rubberised head for extra durability
- Tough polycarbonate housing for heavy industrial use
- Easy ON/OFF tail switch, when wearing gloves
- IP67 Submersible up to 1 metre for 30 mins



# SAFATEX Titan R and RX

Zone 1 and 21 Rechargeable Portable Floodlight, with Magnetic Feet or Metal Stand

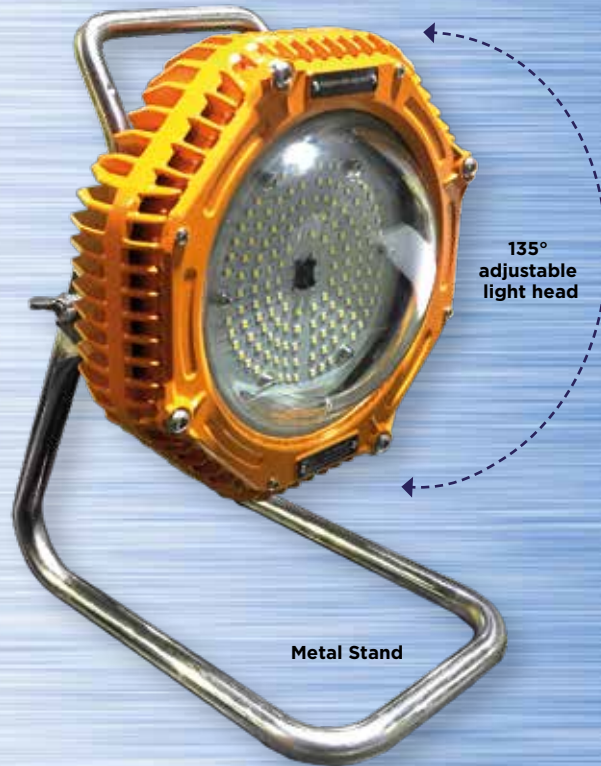

**Choose:**

1400lm (10W)

2100lm (15W)

**Choose:**

**Stainless Steel Stand**

**Magnetic Base**

- High strength aluminium housing
- Rechargeable lithium battery
- Tilttable light head
- Up to 10 hours runtime (R model)
- Carry handle
- Compact, ideal for confined spaces
- Temperature class T4 and T6

**GAS ZONE 1**



**DUST ZONE 21**



4 models available:

	Titan R Stainless Steel Stand	Titan R Magnetic Base	Titan RX Stainless Steel Stand	Titan RX Magnetic Base
	1400 Lumens, 10W		2100 Lumens, 15W	
	Up to 20m beam		Up to 30m beam	
	10hrs runtime		6hrs runtime	
<b>MODE</b>	High		High	
	6.6Ah, Li-ion		6.6Ah, Li-ion	
	3 to 5hrs charging time		3 to 5hrs charging time	
	IP66		IP66	
	209 x 236 x 303mm	46 x 85 x 39mm	209 x 236 x 303mm	46 x 85 x 39mm
	5.2kg	6.5kg	5.2kg	6.5kg
<b>CODE</b>	SA-TITAN-R-STAND	SA-TITAN-R-MAG	SA-TITAN-RX-STAND	SA-TITAN-RX-MAG



Optional Accessories:

3.5m stainless steel tripod: SPTRIODSS

**CERTIFICATION:**

ATEX Zone 1 & 21 and 2 & 22  
 II 2 G Ex db op is IIC T+ Gb  
 II 2 G Ex tb op is IIIC T+ Db  
 FILE NUMBER: EPT 18 ATEX 2977 X

Gas: Ex d IIC T6 T4 Gb  
 Ex tb IIIC T80°C T130°C Db IP66  
 IECEx CQM 15.0039X



Scan for multi-language information



Optional 3.5m Stainless Steel tripod





# New SAFATEX Titan AC Floodlights

Zone 1 and 21, Ideal for Wet Locations and Hose Down Environments



Adjustable brackets

**Choose:**

-  17310lm (one light head)
-  34136lm (two light heads)
-  69120lm (four light heads)

- High strength aluminium housing
- Adjustable bracket
- Low THD around 10%, for less interference
- 6KD Surge protection
- Shock and vibration resistant tempered glass
- Can be ceiling, wall or scaffold mounted

GAS ZONE 1



DUST ZONE 21



3 models available:

	One Head	Two heads	Four heads
	17310 Lumens	34136 Lumens	69120 Lumens
<b>MODE</b>	100-277V AC		
	High		
<b>WATT</b>	120W	240W	480W
	IP66		
	332 x 212 x 142mm	332 x 426 x 142mm	671 x 426 x 142mm
<b>CODE</b>	8.3kg	13kg	27kg
<b>CODE</b>	SA-TITAN-1H	SA-TITAN-2H	SA-TITAN-4H

Optional Accessories: Stanchion bracket or Pole mount bracket



**CERTIFICATION:**



ATEX Zone 1, 2 & 21, 22  
 II 2 G Ex db IIC T\* Gb  
 II 2 D Ex tb IIIC T\* Db IP66  
 FILE NUMBER: TÜV 21 ATEX 8775 X  
 IECEX Certification NO.:  
 IECEX TUR 21.0070X



Scan for multi-language information

# NEW SAFATEX Titan AC + 24V Pendant

Zone 1 and 21, Ideal for Wet Locations and Hose Down Environments



- 5820lm
- 80° Beam
- IP66

- High strength aluminium housing
- Ideal for areas requiring frequent on and off of lights or constant lighting
- Heavy duty and high impact design withstand the harshest indoor and outdoor conditions
- Temperature class T4

2 models available

	Titan Pendant	Titan 24V Pendant
	5820 Lumens	
	80° beam	
MODE	High	
	100-277V AC	24V
	IP66	
	220 x 220mm	
	10.4kg	
CODE	SA-TITAN-PENDANT	SA-TITAN-PENDANT24

CERTIFICATION:



ATEX Zone 1 & 21 and 2 & 22  
 II 2 G Ex db op is IIC T° Gb | II 2 G Ex tb op is IIIC T° Db  
 FILE NUMBER: EPT 18 ATEX 2977 X  
 Gas: Ex d IIC T6 T4 Gb | Ex tb IIIC T80°C T130°C Db IP66 | IECEx CQM 15.0039X

Optional Accessories:

Special order only:



Scan for multi-language information

# SAFATEX Titan 17000

Zone 2 and 22 Powerful AC Fixed Light Fittings



- 17,000lm
- 43m Beam
- IP66

- IK08 High strength Aluminium housing
- Ultra bright LEDs
- Adjustable bracket
- Long range Floodlight
- Shock and vibration resistant tempered glass
- Surge protection
- Explosion proof
- Temperature class T5 and T6

	17000 Lumens
	Up to 43m beam
MODE	High
	110/120V or 220/240V
	IP66
	425.5 x 336mm
	10.4g
CODE	SA-SIGMA-17000

CERTIFICATION:



ATEX Zone 2 & 22  
 3 G Ex nR IIC T5 or T6 Gc  
 3 D Ex tc IIIC T95°C or T85°C Dc  
 FILE NUMBER: TÜV 15 ATEX 7672X

Optional Accessories:  
 Special order only:

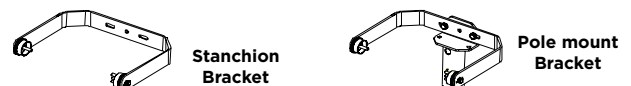

Scan for multi-language information



# SAFATEX Titan Linear

Zone 1 and 21, Ideal for Illuminating Walk Ways and Long Large Areas



7380lm  
 IP66

- High strength aluminium housing
- Impact resistant diffused lens
- Stainless steel bracket for ceiling mount
- Uniformed illumination
- Single-ended feed-through cable or double ended optional available
- Standard 6-12KV surge protection
- Temperature class T6

GAS ZONE 1



DUST ZONE 21



	7380 Lumens 60W
<b>MODE</b>	High
	110-277V 50/60Hz
	IP66
	1285 x 126 x 88mm
	7.5kg
<b>CODE</b>	SA-TITAN-LINEAR

Supplied with 0.6m cable

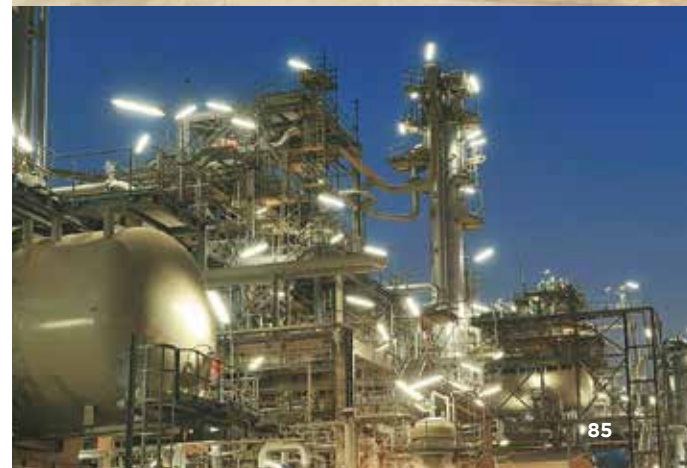

**CERTIFICATION:**

ATEX Zone 1 & 21 and 2 & 22  
 II 2 G Ex emb IIC T6 Gb  
 II 2 D Ex tb IIIC T80°C Db IP66  
 LCIE 20 ATEX 3006 X

Ex eb mb IIC T5 T6 Gb | Ex tb IIIC T80°C Db | IECEx LCIE 20.0018X



Scan for multi-language information





	Up to 1km
	Up to 72hrs runtime
<b>MODE</b>	6 Flashing modes 3 Colour modes: Red   Blue   Amber + Combination of all 3 colours
	3.7V 750mAh, 2.78Wh, Li-ion
	10 to 12hrs charging time
	IP68   IK08
	370 x 150 x 335mm
	5kg
<b>CODE</b>	NSPULSARNAVSTAR

Supplied with 12V/24V Vehicle adaptor and AC mains charger

**Optional Accessories:**  
Magnetic cone mount: SPPULSARMAG



**YouTube**  
Scan for multi-language information



# New Pulsar NavStar

Set of 10 Sequential, Rechargeable, Fast-Deployment Hazard Warning Lights



Multi Coloured LEDs in one:  
Lights can be changed from:  
Blue - Red - Amber  
or combination of all 3 colour modes

Optional magnetic  
cone mount



For fast and easy deployment  
the case can be folded  
back on itself

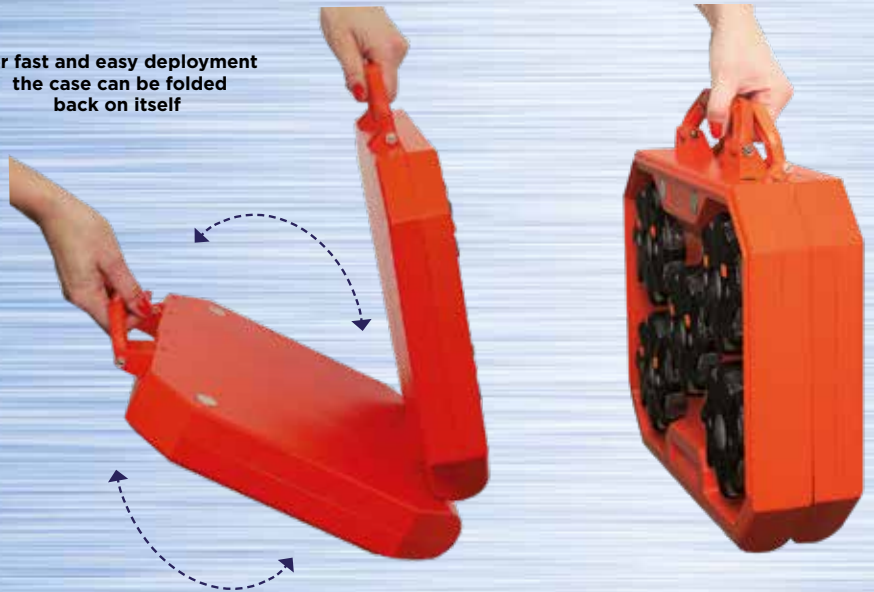

Conforms to schedule 13, Part 10: Traffic signs regulations and general directions 2016 (TSRGD)

-  1km beam
-  72hrs
-  IP68

- Automatic switch on and sequencing
- Fast and safe deployment hazard warning light set
- Rechargeable lithium battery
- Housed in a high-impact, shock resistant and reversible charging case
- 360° illumination zone with 6 flash modes, 4 colour modes
- Simple two-button operation
- Vertical beam for helicopter and drone operations



# Pulsar Pro Range

Designed for Traffic Control, Signalling, Hazard Awareness, Zone Demarcations



Available in blue, yellow green and red



Choose:

Single Pulsar Pro

Set of 5 Pulsar Pro

Set of 5 Sequential Pulsar Pro

1km beam

60hrs

IP67

- 360° Illumination
- Rechargeable Lithium battery
- Alert oncoming traffic of any hazard
- Central white work light
- Magnetic mounting
- High impact resistance and crush proof up to 3 Tonnes
- Supplied in robust charging case

3 models available:

	Single Pulsar Pro	Set of 5 Pulsar Pro	Set of 5 Sequential Pulsar Pro
	Up to 1km beam		
	8 to 60hrs runtime		
	3.7V 700mAh, 3Wh, Li-ion		
	10hrs charging time		
	IP67		
	24 x 100mm ø	Case: 380 x 70 x 370mm	Case: 380 x 70 x 370mm
	200g	2.9kg	2.9kg
<b>CODE</b>	NSPULSARPRO-R/B/Y/G	NSPULSARPRO5-R/B/Y/G	NSPULSARPROSQ-R/B/Y

Supplied with

Single: Charging base, charging cable, car charger

Set of 5: Charging carry case, mains charger and car charger

Light Mode	Runtime
Rotate	9hrs
Quad Flash	9hrs
Single Blink	60hrs
Alternative Blinks	9hrs
SOS Rescue	14hrs
Steady on High	5hrs
Steady on Low	35hrs
2 LED Lights	28hrs
4 LED Lights	18hrs
White Torch mode	8hrs
Sequential mode (Sequential pulsar Pro)	15hrs

COLOUR	MCD
Blue	6,000
Green	11,000
Red	7,000
Yellow	7,500

Optional Accessories:

Magnetic Cone mount: SPPULSARMAG



**YouTube**  
Scan for multi-language information



Scan for multi-language information















# Sequential Pulsar Max

Rechargeable Hazard Lights Ideal for use on High-Speed Roads



CONFORMS TO SCHEDULE 13, PART 10:  
Traffic signs regulations and general directions 2016 (TSRGD)

-  1km beam
-  72+hrs
-  IP68
- 360° Illumination
- Rechargeable Lithium battery
- Alert oncoming traffic of any emergency
- Float in water
- Magnetic mounting
- Crush proof up to 3 Tonnes

	Up to 1km beam
	72+ hours runtime
<b>MODE</b>	Sequential
	3.7V 3000mAh, 12Wh, Li-ion
	7hrs charging time
	IP68
	380 x 370 x 65mm
	2.65kg
<b>CODE</b>	NSPULSARMAXSQ-B



Hazardous Warning Lights

Supplied with charging case, mains charger + vehicle charger

**Optional Accessories:**  
UK or EU Adaptor: CH-USB-UK/EU  
Magnetic Cone mount: SPPULSARMAG











# Single Pulsar AAA

3 x AAA Multi Mode Hazard Warning Lights



Available in  
yellow, blue  
red and green

-  1km beam
-  240hrs
-  IP67
- 360° Illumination
- Rechargeable Lithium battery
- Alert oncoming traffic of any hazard
- Float in water
- Magnetic mounting
- Crush proof up to 3 Tonnes

	Up to 1km beam
	240hrs runtime
	3 x AAA Alkaline batteries
	IP67
	340 x 110mm ø
	170g
<b>CODE</b>	NSPULSARAAA-B/G/Y

Supplied with 3 x AAA alkaline batteries



Light Mode	Runtime
Rotate	52hrs
Quad Flash	120hrs
Single Blink	240hrs
Alternative Blinks	18hrs
SOS Rescue	22hrs
Steady on High	10hrs
Steady on Low	25hrs
2 LED Lights	52hrs
4 LED Lights	25hrs
White Torch Mode	60hrs

COLOUR	MCD
Blue	6,000
Green	11,000
Red	7,000
Yellow	7,500



# HazStar

Rechargeable, Work Light and Rear Red Hazard Lights



Robust edge protection with metal body



Removable rear red lights magnetically mountable so they can be placed around a vehicle



- 2000lm
- 15m Beam
- 3 to 9hrs
- IP65

- Alert oncoming traffic of any hazard with rear red hazard light with 100m visibility
- Front work light with 15m beam and 6 hour runtime
- Rechargeable Lithium-Ion battery
- Battery status indicators
- Power bank to charge mobile devices
- IK07 Shock proof

	2000 Lumens
	Up to 15m beam
	3 to 9hrs runtime
<b>MODE</b>	Work light: High   Medium   Low Removable lights: Flashing   High
	Work light: 3.7V 5000mAh, 19Wh, Li-ion
	5hrs charging time
	IP65
	255 x 90 x 34mm
	956kg
<b>CODE</b>	NSHAZSTAR

Supplied with USB charging cable

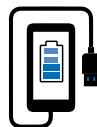

Scan for multi-language information

Power bank to charge your phone



# LifeGuard

5-In-1 Light Will Save Your Life! Every Vehicle Should Have One!

Seat belt cutter



Window breaker



Inspection torch



200 Lumens

2.5 to 5hrs runtime

MODE Work light | Torch | Emergency Light

3 x AAA Alkaline batteries

158 x 47.3mm

127g

CODE NSLIFEGUARD



Supplied with 3 x AAA Alkaline batteries

Optional Accessories:  
Holder, Velcro pocket clip

200lm

2.5 to 5hrs

- Emergency car kit
- Work light + inspection torch
- Window breaker
- Seat belt cutter
- Red flashing emergency lights



# StarBooster

5 in 1 Emergency Starter Car Kit



Insulated Jump leads



500 Lumens

4 to 75hrs runtime

MODE Work light | Torch | Emergency Light

11.1V 3 x 2600mAh, 29Wh, Li-ion

4hrs charging time

166 x 96 x 31.5mm

447g

CODE NSSTARBOOSTER



Supplied with insulated jump cables, USB cable and AC mains charger

Jump starts



MAX ENGINE SIZE

3.0L Petrol



2.0L Diesel

- Work light + inspection torch
- Portable jump starter
- Reverse polarity protection
- Red flashing emergency lights
- Fits in your pocket or glove box
- Magnetic handle
- Battery status indicators

500lm

4 to 75hrs



# New iSpector UBL

Under-Bonnet Cordless Rechargeable Light

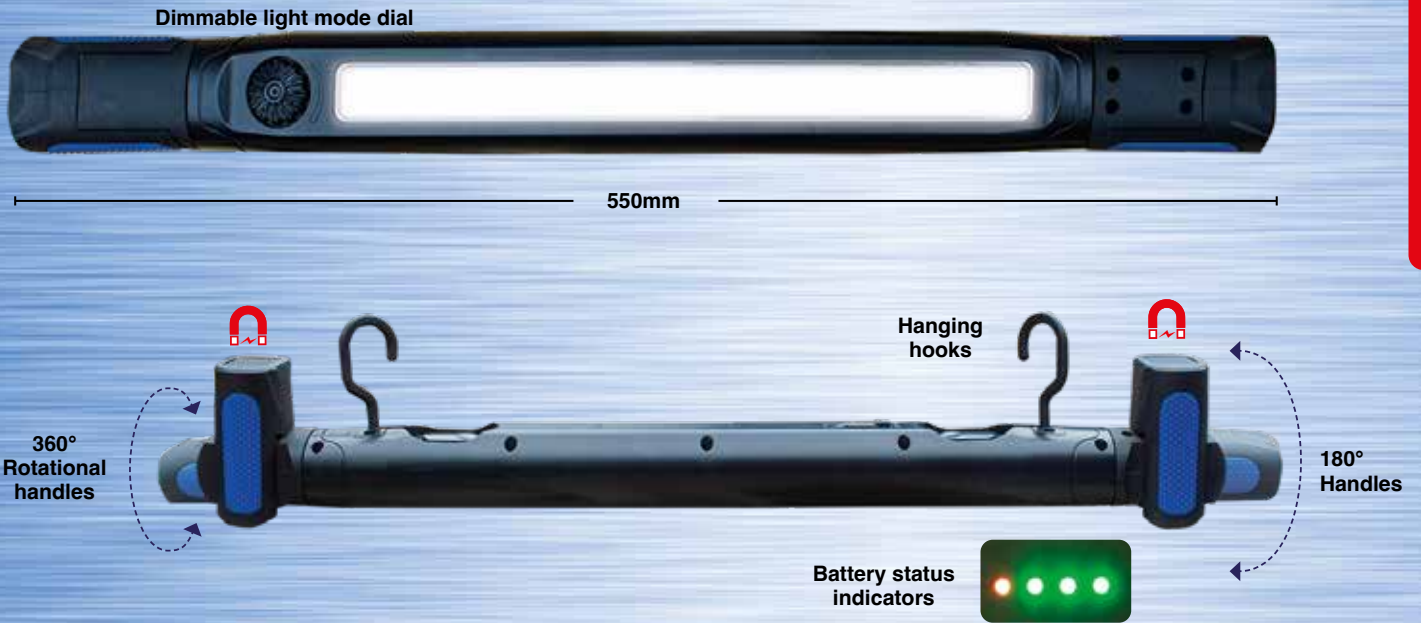

- 80 - 1200lm
- 10m Beam
- 2 to 15hrs
- IP44

- Dual 180° ratcheting handles and 360° twist function to direct light exactly where you need it
- Dual hanging hooks and strong magnetic bases for hands free use
- Rechargeable and cordless via USB C charging cable
- Tough ABS construction
- Virtually unbreakable polycarbonate lens
- White light with 5000K colour temperature
- Battery status indicators

	80 - 1200 Lumens
	Up to 10m beam
	2 to 15hrs
<b>MODE</b>	Dimmable
	3.7V 4000mAh, 15Wh, Li-ion
	4.5hrs charging time
	IP44   IK07
	520x41x47mm
	480g
<b>CODE</b>	NSI-SPECTORUBL

Supplied with type C USB charging cable

**Optional Accessories:**

UK or EU adaptor: CH-USB-UK/EU

12/24V Vehicle charger: CHIC3.7-LI-ION





# Pocket Pro

## Rechargeable Pocket Sized Work Light and Torch

Narrow torch  
directional  
focused light

Wide work  
light beam



- 600lm
- 30m Beam
- 2.5 to 6hrs

- Work light + inspection torch
- Hanging hook
- Conveniently fits in your pocket
- Battery status + charging indicator
- Resistant to workshop chemicals & solvents

	600 Lumens
	Up to 30m beam
	2.5 to 6hrs runtime
<b>MODE</b>	Work light: High   Torch: High + Low
	3.7V 1400mAh, 6Wh, Li-ion
	2.5hrs charging time
	61 x 35 x 118mm
	126g
<b>CODE</b>	NSPOCKETPRO

Supplied with type C USB charging cable

**Optional Accessories:**

- UK or EU adaptor: CH-USB-UK/EU
- 12/24V Vehicle charger: CHIC3.7-LI-ION



# iSpector Pocket

## Rechargeable Pocket Sized Light

Wide work  
light beam

Narrow torch  
directional  
focused light



- 350lm
- 1.5 to 5.5hrs

- Work light and inspection torch
- Magnetic Pocket clip and base for hands free use
- Conveniently fits in your pocket
- Battery status + charging indicator
- Resistant to workshop chemicals & solvents

	350 Lumens
	1.5 to 5.5hrs runtime
<b>MODE</b>	Work light: High + Low   Torch: High
	3.7V 1100mAh, 4Wh, Li-ion
	3hrs charging time
	Case: 190 x 25 x 35mm
	104g
<b>CODE</b>	NSI-SPECTORPOCKET

Supplied with type C USB charging cable

**Optional Accessories:**

- UK or EU adaptor: CH-USB-UK/EU
- 12/24V Vehicle charger: CHIC3.7-LI-ION



# New iSpector Mini

## Rechargeable Slim Folding Pocket Light



Rear light fits in the smallest of spaces

Narrow torch directional focused light



Wide work light beam

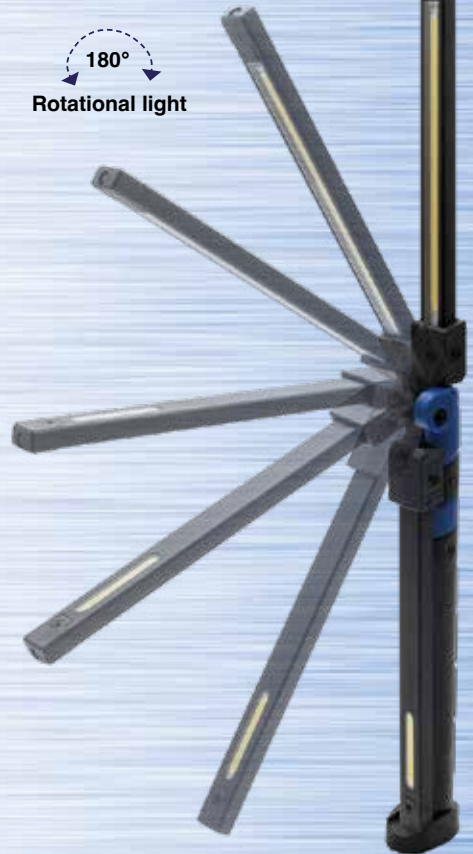

180°  
Rotational light

- 280lm
- 10m Beam
- 1.5 to 4.5hrs
- IP44

- Multi-directional, three built-in LED lamp heads
- Ultra lightweight compact pocket size
- 6x12.2mm slim blade-like design
- Resistant to chemicals and solvents
- Anti-slip grip
- Super tough aluminium housing
- Two hours quick-charge USB-C connection

	280 Lumens
	Up to 10m beam
	1.5 to 4.5hrs
<b>MODE</b>	Work light: High + Low   Rear light   Torch
	3.7V 750mAh, 3Wh, Li-ion
	2hrs charging time
	IP44   IK07
	30x19x306mm
	80g
<b>CODE</b>	NSI-SPECTORMINI

Supplied with type C USB charging cable

**Optional Accessories:**

UK or EU adaptor: CH-USB-UK/EU

12/24V Vehicle charger: CHIC3.7-LI-ION





# iSpector Flex

Rechargeable 360° Flexible Arm Inspection Light



360°  
Flexible light head

On/Off Dimmer switch

500lm  
2 to 16hrs

- Work light + inspection torch
- Hanging hook
- Battery status + charging indicator
- Resistant to workshop chemicals & solvents

	50-500 Lumens
	2 to 16hrs runtime
<b>MODE</b>	Dimmable work light   Torch
	3.7V 2600mAh, 10Wh, Li-ion
	4hrs charging time
	432x65.5x44.5mm
	290g
<b>CODE</b>	NSI-SPECTORFLEX



YouTube

Supplied with USB adaptor (UK) + charging cable

Optional Accessories:

- UK or EU adaptor: CH-USB-UK/EU
- 12/24V Vehicle charger: CHIC3.7-LI-ION



# TriSpector

Car Professionals Set, 3-in-1 Rechargeable Inspection Kit



- 3 x Quick release light heads:
- Spot-to-flood flashlight
  - Flexible light for versatile inspections
  - Slim line head with work light and torch for inspection in difficult to reach areas

360°  
Rotation body

600lm  
30m Beam  
3.5 to 10hrs  
IP44

- Powerful magnetic base
- Hanging hook
- Battery status + charging indicator
- Resistant to workshop chemicals & solvents
- Supplied in a protective case

	Flexible light: 80 Lumens Flashlight: 10-300 Lumens Slimline Work light: 600 Lumens Torch: 100 Lumens
	2.5 to 10hrs runtime
<b>MODE</b>	Flexible light: High   Low Flashlight: High   Low Slimline Work light + Torch: High
	3.7V 2600mAh, 10Wh, Li-ion
	4hrs charging time
	IP44   IK07
	Case: 420x66x45mm
	290g
<b>CODE</b>	NSTRI-SPECTOR



YouTube

Supplied with USB adaptor (UK) + charging cable and protective case



# New iSpector 750

Rechargeable 2-in-1 Inspection Light with Multi-directional Base



Wide work light beam



Narrow torch directional focused light

- 750lm
- 40m Beam
- 2 to 7hrs
- IP65

- Multi-directional 360° rotational base
- 2-in-1 work light and inspection torch
- Cordless heavy duty design with toughened optical lens
- Resistant to chemicals and solvents
- Strong magnetic base and back
- Battery status indicators
- Three hours quick-charge USB-C connection



	750 Lumens
	Up to 40m beam
	2 to 7hrs runtime
<b>MODE</b>	Work light: High, Low   Torch
	3.7V 2600mAh, 10Wh, Li-ion
	4hrs charging time
	IP65   IK07
	194x41x59mm
	337g
<b>CODE</b>	NSI-SPECTOR750

Supplied with USB-C fast charging cable

**Optional Accessories:**

UK or EU adaptor: CH-USB-UK/EU  
12/24V Vehicle charger: CHIC3.7-LI-ION

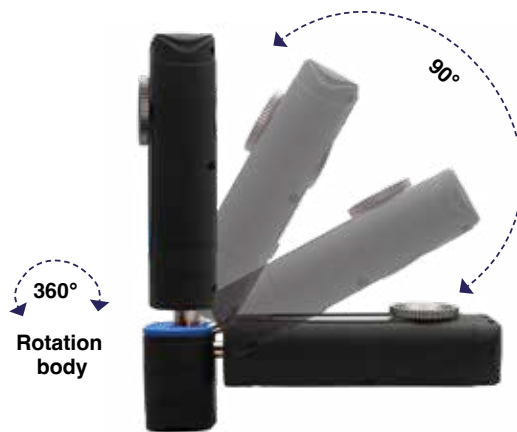

Battery Status indicators





# Micro 1000

## Rechargeable Compact Wide Area Work Light



	1000 Lumens
	2 to 4hrs runtime
<b>MODE</b>	High   Low
	3.7V 2600mAh, 10Wh, Li-ion
	4hrs charging time
	IP65   IK07
	78 x 76 x 52mm
	220g
<b>CODE</b>	NSMICRO1000



Supplied with USB charging cable



1000lm

2 to 4hrs

IP65

- Ideal for Confined Spaces
- Compact design, fits in the palm of your hand
- Glass lens for 90° degrees
- Aluminium heat sink
- Small enough for the tool box
- Battery overcharge + discharge protection
- Resistant to workshop chemicals & solvents

# PocketStar

## Hi Vis Pocket Inspection Light, Ideal for Close up Work



	150 Lumens
	4hrs runtime
<b>MODE</b>	High
	3 x AAA Alkaline batteries
	158 x 76 x 17mm
	54g
<b>CODE</b>	NSPOCKETSTAR



Supplied with 3 x AAA Alkaline batteries



150lm

4hrs

- Produces clear white light
- Wide angle beam
- Compact, pocket sized
- Polycarbonate lens
- Rubberised ABS yellow casing
- Resilient polycarbonate/ABS construction

# Pro250

Rechargeable Twist and Swivel Inspection Light with Charging Base



	250 Lumens
	2.5 to 6hrs runtime
<b>MODE</b>	Work light: High Torch: High
	3.7V 2200mAh, 9Wh, Li-ion
	4hrs charging time
	196 x 80mm ø
	320g
<b>CODE</b>	NSPRO250



Automotive Lights

Supplied with AC mains charger, 12V + 24V DC, vehicle charger, charging base, Micro USB cable

- 250lm
- 2.5 to 6hrs

- Work light and inspection torch
- Produces clear white light similar to daylight
- 360° rotation and 180° ratcheting
- Battery status and charging indicators
- Hanging hook
- Anti-slip comfortable grip
- Resilient polycarbonate and ABS construction



# StarBlade

Rechargeable Slimline Inspection Light that Illuminates Hard to Reach Areas



	300 Lumens
	3hrs runtime
<b>MODE</b>	High
	3.7V 2200mAh, 9Wh, Li-ion
	4hrs charging time
	338 x 42 x 6mm
	148g
<b>CODE</b>	NSSTARBLADE



Supplied with USB adaptor (UK) + charging cable

- 300lm
- 3hrs

- Slim blade design
- Narrow floodlight to illuminate hard to reach areas
- Exceptional clear white light output
- Hanging hook and magnetic base
- Battery status + charging indicator
- Resistant to workshop chemicals & solvents







**UK**  
 NightSearcher Ltd  
 Unit 4, Applied House, Fitzherbert Spur,  
 Farlington, Hampshire, PO6 1TT, UK  
 023 9238 9774  
 sales@nightsearcher.co.uk  
 www.nightsearcher.co.uk



**Poland**  
 NightSearcher Export  
 Garbary 53, Poznan  
 Poland  
 +48 61 624 29 98  
 exportsales@nightsearcher.com  
 www.nightsearcher.com



**Germany**  
 NightSearcher Lichttechnik  
 Stadtweide 17 46446 Emmerich  
 am Rhein, Deutschland  
 +49 282 2602 3110  
 info@nightsearcher-lichttechnik.de  
 www.nightsearcher-lichttechnik.de



All new products are designed to minimise our impact on the environment.



NightSearcher continue to produce these products from our UK head office in Portsmouth, UK

**Our Quality Assurance | Your Peace Of Mind**

