

WIG/TIG Gorionici za zavarivanje

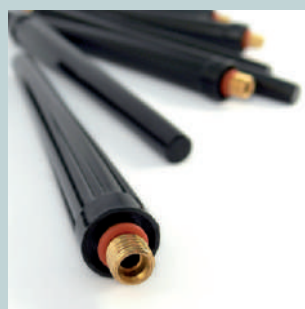

WIG/TIG informacije za narudžbu

Plinsko (zračno) hlađenje gorionika	4 ... 5
Vodeno hlađenje gorionika	6 ... 8
Modeli s nožnim prekidačem	9

Rezervni dijelovi i potrošni materijal

TBi SR 9, TBi SR 20, TBi SR 21	10 ... 11
TBi SR 17, TBi SR 18, TBi SR 26	12 ... 13
MultiLock Modeli	14
TBi XCT 200W, TBi XCT 400W	15
TBi SR 24G, TBi SR 24W	16
TBi SR 25G FX, TBi SR 25W FX	17
TBi AW 424, TBi AW 427	18
TBi SR 400, TBi SR 12	19

Ručka i moduli

Precizne ručke	20
Cijevi ručke i prekidači	22
Drške cijevi za tijelo gorionika sa ventilom	23
Modeli sa nožnim prekidačima	24 ... 25

Strojni gorionici

Strojni gorionici	26
-------------------	----

Potrošni materijal

Potrošni materijal	27
--------------------	----

Pribor

TIG dodavača žice	28
TIG montažni uređaj	29
TBi Tungsten elektrode	29

Zračno (plinsko) hlađenje



TBi SR 9 (FX) TBi SR 17 (FX) TBi TM 125 TBi SR 26 (FX) TBi SR 26 HD (FX)

Model	Standard	Standard, FX	415P09	413P09	415P17	413P17	*	415P26	413P26	-
M12x1	Standard	Standard, FX	0	0	0	0	*	0	0	-
	Standard, FX	Standard, FX	0	0	0	0	-	0	0	-
G 1/4"	Standard	Standard, FX	2	2	2	2	*	2	2	-
	Standard, FX	Standard, FX	2	2	2	2	-	2	2	-
G 3/8"	Standard	Standard, FX	3	3	3	3	*	3	3	-
	Standard, FX	Standard, FX	3	3	3	3	-	3	3	-
TSB 10/25 (Ø 9 mm)	Standard	Standard, FX	3B	3B	3B	3B	*	3B	3B	-
	Standard, FX	Standard, FX	3B	3B	3B	3B	-	3B	3B	-
TSB 35/50 (Ø 13 mm)	Standard	Standard, FX	3C	3C	3C	3C	*	3C	3C	415P28 3C
	Standard, FX	Standard, FX	3C	3C	3C	3C	-	3C	3C	413P28 3C
TSB 10/25 Mono (Ø 9 mm)	Standard	Standard, FX	B	B	B	B	402P5MCLC *	*		-
	Standard, FX	Standard, FX	B	B	B	B	-	*		-
TSB 35/50 Mono (Ø 13 mm)	Standard	Standard, FX	C	C	C	C	*	C	C	-
	Standard, FX	Standard, FX	C	C	C	C	-	C	C	-
Euro-W5G	Standard	Standard, FX	Y	Y	Y	Y	*	Y	Y	-
	Standard, FX	Standard, FX	Y	Y	Y	Y	-	Y	Y	-
Euro-GZ	Standard	Standard, FX	9	9	9	9	*	8	8	-
	Standard, FX	Standard, FX	9	9	9	9	-	8	8	-

Svi priključci za gorionike za sva napajanja su dostupni. Više informacija na zahtjev.

NAPOMENA
TIG glava se naručuje zasebno.

Naznači u kućicu željenu vrstu prekidača.

C		Dvostruki prekidač
P		Dvostruki prekidač sa potencijetrom 10 kΩ
D		Dvostruka poluga



TBi SR 24G	TBi SR 25G FX	TBi SR 9 V (FX)	TBi SR 17 V (FX)	TBi SR 26 V (FX)	TBi SR 26 HDV(FX)	TBi SR 9 P (Aut)	TBi SR 26 P (Aut)	TBi Aut 22G
415P23 0	-	405P09V 0	405P17V 0	405P26V 0	-	491P09700	491P26700	491P23700
-	413P25 0	403P09V 0	403P17V 0	403P26V 0	-	-	-	-
415P23 2	-	405P09V 2	405P17V 2	405P26V 2	-	491P09702	491P26702	491P23702
-	413P25 2	403P09V 2	403P17V 2	403P26V 2	-	-	-	-
415P23 3	-	405P09V 3	405P17V 3	405P26V 3	-	491P09703	491P26703	491P23703
-	413P25 3	403P09V 3	403P17V 3	403P26V 3	-	-	-	-
415P23 3B	-	405P09V3B	405P17V3B	405P26V3B	-	491P0970B	-	-
-	413P25 3B	403P09V3B	403P17V3B	403P26V3B	-	-	-	-
415P23 3C	-	405P09V3C	405P17V3C	405P26V3C	405P28V3C	491P0970C	491P2673C	-
-	413P25 3C	403P09V3C	403P17V3C	403P26V3C	403P28V3C	-	-	-
*	-	*	*	*	-	*	*	491P2371B
-	*	*	*	*	-	-	-	-
*	-	*	*	*	-	*	*	491P2371C
-	*	*	*	*	-	-	-	-
415P23 Y	-	*	*	*	-	*	*	*
-	413P25 Y	*	*	*	-	-	-	-
415P23 9	-	*	*	*	-	491P09709	491P26708	*
-	413P25 9	*	*	*	-	-	-	-

Molimo Vas da naznačite željeni tip kabela.

1 Gumena vanjska navlaka (standard).

L Zaštitna koža naprijed (0.6 m), ostalo tekstil.

T Tekstilna zaštita.

Molimo Vas da naznačite željenu dužinu.

4 4 m / 12 ft

8 8 m / 25 ft

* Broj (SKU) proizvoda na zahtjev

Vodeno hlađenje gorionika



			TBi SR 18 (FX)	TBi SR 20 (FX)	TBi SR 21 (FX)	TBi TM 250	TBi SR 24W (FX)
	M12x1	Standard	415P18 0	415P20 0	415P21 0	*	415P24 0
		Standard, FX	413P18 0	413P20 0	413P21 0	-	413P24 0
	G 1/4"	Standard	415P18 2	415P20 2	415P21 2	*	415P24 2
		Standard, FX	413P18 2	413P20 2	413P21 2	-	413P24 2
	G 3/8"	Standard	415P18 3	415P20 3	415P21 3	*	415P24 3
		Standard, FX	413P18 3	413P20 3	413P21 3	-	413P24 3
	TSB 35/50 (Ø 13 mm)	Standard	415P18 C	415P20 C	415P21 C	402P6MCLC	415P24 C
		Standard, FX	413P18 C	413P20 C	413P21 C	-	413P24 C
	Euro-W5W	Standard	415P18 Y	415P20 Y	415P21 Y	*	415P24 Y
		Standard, FX	413P18 Y	413P20 Y	413P21 Y	-	413P24 Y
	Euro-WZ-0	Standard	415P18 5	415P20 5	415P21 5	*	415P24 5
		Standard, FX	413P18 5	413P20 5	413P21 5	-	413P24 5

Svi priključci za gorionike za sva napajanja su dostupni. Više informacija na zahtjev.

▲ NAPOMENA

TIG glava se naručuje zasebno.



Naznači u kućicu željenu vrstu prekidača.

C		Dvostruki prekidač
P		Dvostruki prekidač sa potencijetrom 10 kΩ
D		Dvostruka poluga



Neu / New
Nouveauté

TBi SR 25W FX **TBi AW 424** **TBi AW 427** **TBi SR 400** **TBi XCT 200W** **TBi XCT 400W** **TBi SR 12** **TBi SR 18 V (FX)** **TBi SR 20 V (FX)**

- 401P25 0	414P24 0 -	404P27 0 -	415P40 0 -	415PX2 0 -	415PX4 0 -	405P12R 0 -	405P18V 0 403P18V 0	405P20V 0 403P20V 0
- 401P25 2	414P24 2 -	404P27 2 -	415P40 2 -	415PX2 2 -	415PX4 2 -	405P12R12 -	405P18V 2 403P18V 2	405P20V 2 403P20V 2
- 401P25 3	414P24 3 -	404P27 3 -	415P40 3 -	415PX2 3 -	415PX4 3 -	405P12R13 -	405P18V 3 403P18V 3	405P20V 3 403P20V 3
- 401P25 C	414P24 C -	404P27 C -	415P40 C -	415PX2 C -	415PX4 C -	405P12R1C -	405P18V C 403P18V C	405P20V C 403P20V C
- 401P25 Y	414P24 Y -	404P27 Y -	415P40 Y -	415PX2 Y -	415PX4 Y -	405P12R1Y -	405P18V Y 403P18V Y	405P20V Y 403P20V Y
- 401P25 5	414P24 5 -	404P27 5 -	415P40 5 -	415PX2 5 -	415PX4 5 -	405P12R15 -	405P18V 5 403P18V 5	405P20V 5 403P20V 5

Molimo Vas da naznačite željeni tip kabela.

1 Gumena vanjska navlaka (standard)

L Zaštitna koža naprijed (0.6 m), ostalo tekstil.

T Tekstilna zaštita.

Molimo Vas da naznačite željenu dužinu.

4 4 m / 12 ft

8 8 m / 25 ft

* Broj (SKU) proizvoda na zahtjev.

Vodeno hlađenje gorionika



TBi SR 18 P (Aut) TBi SR 20 P (Aut) TBi Aut 22W

	M12x1	Standard	491P18700	491P20700	491P22700
	G 1/4"	Standard	491P18702	491P20702	491P22702
	G 3/8"	Standard	491P18703	491P20703	491P22703
	TSB 35/50 (Ø 13 mm)	Standard	491P1870C	491P2070C	491P2270C
	Euro-W5W	Standard	491P1870Y	491P2070Y	491P2270Y
	Euro-WZ-0	Standard	491P18705	491P20705	491P22705

Svi priključci za gorionike za sva napajanja su dostupni. Više informacija na zahtjev.

Molimo Vas da naznačite željenu dužinu.

4 4 m / 12 ft

8 8 m / 25 ft

Modeli sa nožnim prekidačem

Plinsko (zračno) hlađenje gorionika



			TBi SR 9 (FX)	TBi SR 17 (FX)	TBi SR 26 (FX)	TBi SR 24G
	TSB 35/50 (Ø 13 mm)	Standard Standard, FX	405P917 1 403P917 1	405P917 2 403P917 2	405P917 5 403P917 5	405P917 7 -
	TSB 35/50 Mono (Ø 13 mm)	Standard Standard, FX	405P91761 403P91761	405P91762 403P91762	405P91765 403P91765	405P91767 -

Vodeno hlađenje gorionika



			TBi SR 18 (FX)	TBi SR 20 (FX)	TBi SR 21 (FX)	TBi SR 400	TBi SR 24W (FX)
	TSB 35/50 (Ø 13 mm)	Standard Standard, FX	405P917 3 403P917 3	405P917 4 403P917 4	405P917 9 -	405P917 8 -	405P917 6 403P917 6

Molimo Vas da naznačite željeni tip kabela.

- 5** Gumena vanjska navlaka (standard)
- L** Zaštitna koža naprijed (0.6 m), ostalo tekstil.
- T** Tekstilna zašita

Molimo Vas da naznačite željenu dužinu.

- 4** 4 m / 12 ft
- 8** 8 m / 25 ft

Ostali modeli na zahtjev

TBi SR 25G,
TBi SR 25W

NAPOMENA

Potrebno je napomenuti da tijela gorionika za modele TBi SR 18, TBi SR 26 i TBi SR 400 je različit od tijela gorionika za preciznu dršku.

TBi SR 9 , TBi SR 20 , TBi SR 21



TBi SR 9 (FX)

Plinsko (zračno)
hladeni gorionik

60% (10 min.)
AC: 80 A
DC: 110 A
Ø 0.5-1.6 mm



TBi SR 20 (FX)

Vodeno hladeni
gorionik

100% (10 min.)
AC: 160A
DC: 220A
Ø 0.5-3.2 mm



TBi SR 21 (FX)

Vodeno hladeni
gorionik

100% (10 min.)
AC: 240A
DC: 340A
Ø 0.5-3.2 mm

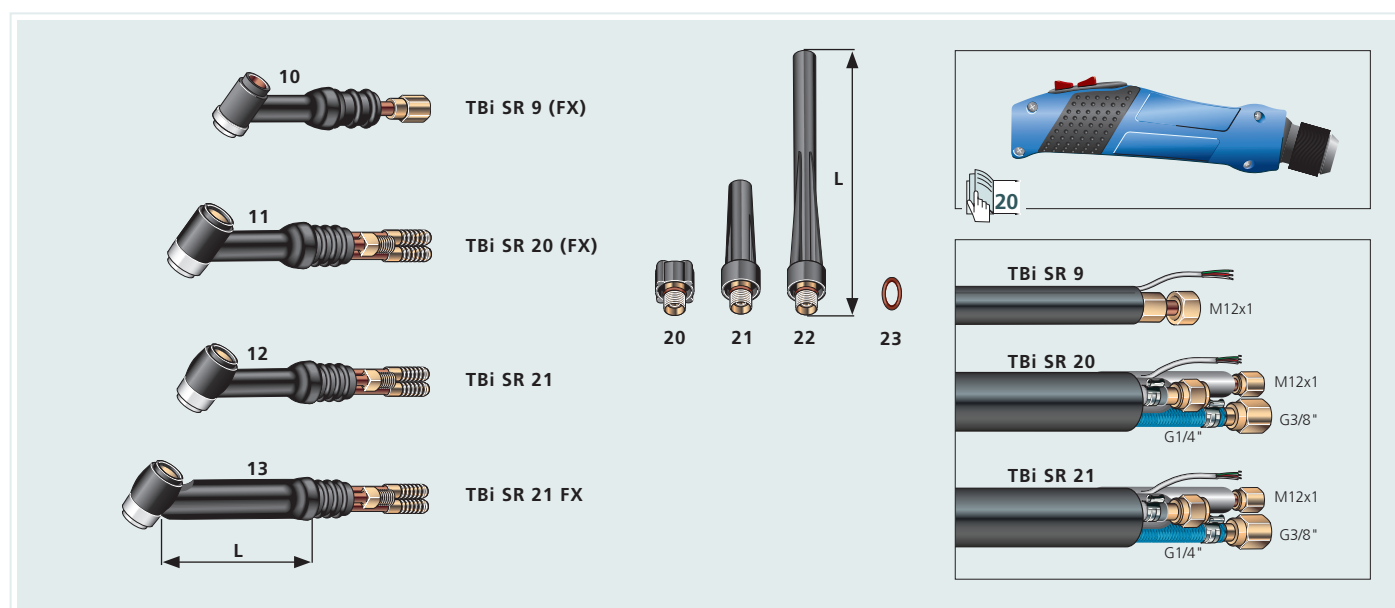

Rezervno dijelovi

10	Tijelo gorionika	SR 9		L = 35 mm	405P090800
10	Tijelo gorionika	SR 9 FX (Standard)	<i>Fleksibilno</i>	L = 35 mm	403P090800
10	Tijelo gorionika	SR 9 FX-L	<i>Fleksibilno</i>	L = 115 mm	403P090805
11	Tijelo gorionika	SR 20		L = 35 mm	405P200800
11	Tijelo gorionika	SR 20 FX (Standard)	<i>Fleksibilno</i>	L = 35 mm	403P200700
11	Tijelo gorionika	SR 20 FX-L	<i>Fleksibilno</i>	L = 70 mm	403P200850
11	Tijelo gorionika	SR 20 FX-LL	<i>Fleksibilno</i>	L = 90 mm	403P200750
11	Tijelo gorionika	SR 20 FX-XL	<i>Fleksibilno</i>	L = 115 mm	403P200800
12	Tijelo gorionika	SR 21		L = 35 mm	405P210800
13	Tijelo gorionika	SR 21 FX (Standard)	<i>Fleksibilno</i>	L = 65 mm	403P210700
13	Tijelo gorionika	SR 21 FX-L	<i>Fleksibilno</i>	L = 115 mm	403P210701
20	Kapa	Kratka		L = 18 mm	41V33 401P200100
21	Kapa	Srednje		L = 48 mm	41V35 401P200200
22	Kapa	Duga		L = 145 mm	41V24 401P200300
23	O-Ring /				98W77 365P200046

Potrošni materijal



▶ A	Izolator	Standard	598882	402P200900
B	Adapter	Jumbo plinsko sito	54N63-20	401P200905

▶ = Standard

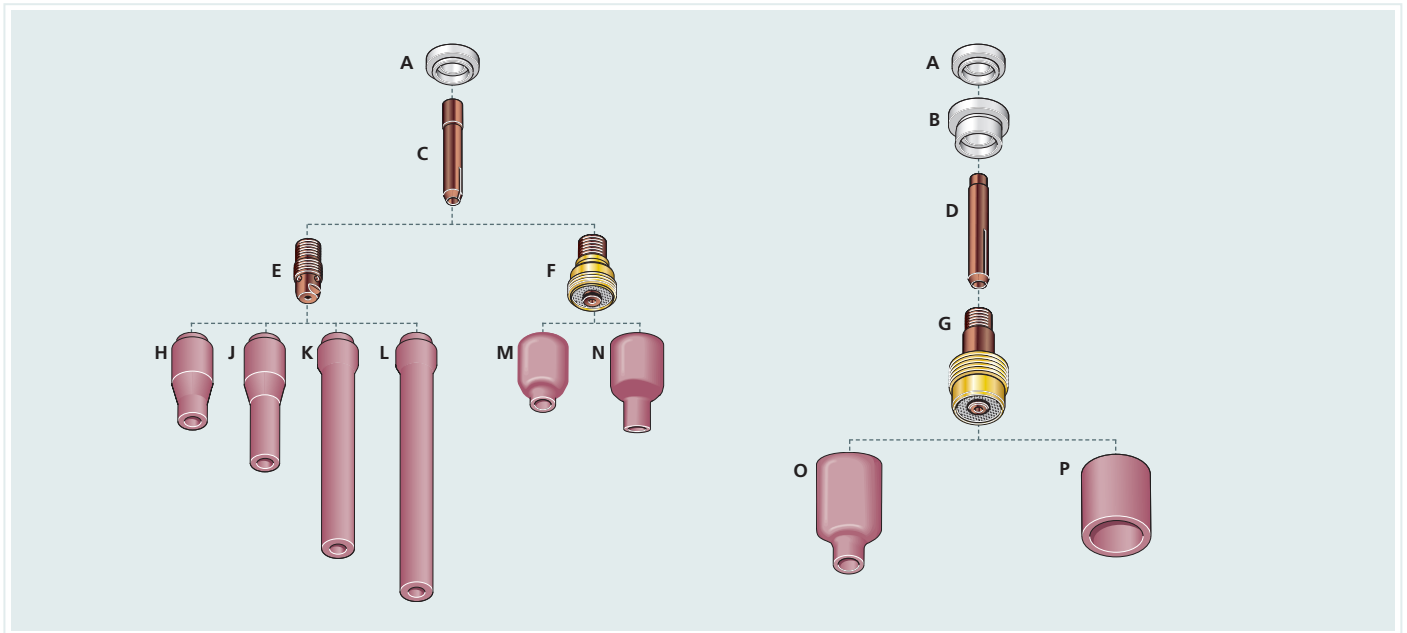

	Ø 0.5 mm Ø 0.020"	Ø 1.0 mm Ø 0.040"	Ø 1.6 mm Ø 1/16"	Ø 2.0 mm	Ø 2.4 mm Ø 3/32"	Ø 3.0 mm	Ø 3.2 mm Ø 1/8"
--	----------------------	----------------------	---------------------	----------	---------------------	----------	--------------------

Držači wolfram elektrode

▶ C	Standard, L = 25.4 mm	13N20 401P200599	13N21 401P200600	13N22 401P200601	- 401P200604	13N23 401P200602	- 401P200605	13N24 401P200603
D	Jumbo, L = 40.1 mm	-	13N21L 401P13N21L	13N22L 401P13N22L	-	13N23L 401P13N23L	-	13N24L 401P13N24L

Nosači wolfram elektrode

▶ E	L = 20.6 mm	Ø 0.5 - 1.6 mm 13N27 401P201001		Ø 2.0 - 2.4 mm 13N28 401P201002		Ø 3.0 - 3.2 mm 13N29 401P201003	
-----	-------------	---------------------------------------	--	---------------------------------------	--	---------------------------------------	--

Plinsko sito

F	Standard, L=21.5 mm	-	45V42 401P201300	45V43 401P201301	Ø 2.0 - 2.4 mm 45V44 401P201302		Ø 3.0 - 3.2 mm 45V45 401P201303	
G	Jumbo, L=40.5 mm	-	45V0204S 401P201350	45V116S 401P201351	Ø 2.0 - 2.4 mm 45V64S 401P201352		Ø 3.0 - 3.2 mm 995795S 401P201353	

	No. 3 Ø 5.0 mm Ø 3/16"	No. 4 Ø 6.5 mm Ø 1/4"	No. 5 Ø 8.0 mm Ø 5/16"	No. 6 Ø 9.5 mm Ø 3/8"	No. 7 Ø 11 mm Ø 7/16"	No. 8 Ø 12.5 mm Ø 1/2"	No. 10 Ø 16 mm Ø 5/8"
--	------------------------------	-----------------------------	------------------------------	-----------------------------	-----------------------------	------------------------------	-----------------------------

Keramičke sapnice

▶ H	Standard, L=30.0 mm	-	13N08 401P201106	13N09 401P201107	13N10 401P201108	13N11 401P201109	13N12 401P201110	13N13 401P201111
J	Standard, L, L=48.0 mm	796F70 401P201115	796F71 401P201116	796F72 401P201117	796F73 401P201118	-	-	-
K	Standard, XL, L=63.0 mm	-	796F75 401P201126	796F76 401P201127	796F77 401P201128	-	-	-
L	Standard, XXL, L=89.0 mm	-	796F79 401P201136	-	-	-	-	-

	No. 4 Ø 6.5 mm Ø 1/4"	No. 5 Ø 8.0 mm Ø 5/16"	No. 6 Ø 9.5 mm Ø 3/8"	No. 7 Ø 11 mm Ø 7/16"	No. 8 Ø 12.5 mm Ø 1/2"	No. 10 Ø 16 mm Ø 5/8"	No. 12 Ø 19 mm Ø 3/4"	Ø 24 mm
--	-----------------------------	------------------------------	-----------------------------	-----------------------------	------------------------------	-----------------------------	-----------------------------	---------

Keramičke sapnice

M	Plinsko sito, L=25.5 mm	53N58 401P201400	53N59 401P201401	53N60 401P201402	53N61 401P201403	53N61S 401P201404	- 401P201409	-	-
N	Plinsko sito, L, L=35.0 mm	53N58L 401P201408	53N59L 401P201405	53N60L 401P201406	53N61L 401P201407	-	401P201410	-	-
O	Jumbo plinsko sito L=48.0 mm	-	-	57N75 401P201451	-	57N74 401P201452	53N88 401P222250	53N87 401P222251	53N89-L 401P222253
P	Jumbo plinsko sito (kratka), L=34.0 mm	-	-	-	-	-	-	-	53N89 401P222252

▶ = Standard

TBi SR 17 , TBi SR 18 , TBi SR 26



TBi SR 17 (FX) Plinsko (zračno) hlađenje

60% (10 min.)
AC: 100 A
DC: 140 A
Ø 0.5-2.4 mm

TBi SR 17



TBi SR 18 (FX) vodeno hlađenje

100% (10 min.)
AC: 225 A
DC: 320 A
Ø 0.5-4.0 mm

TBi SR 18



TBi SR 26 (FX) Plinsko (zračno) hlađenje

60% (10 min.)
AC: 140 A
DC: 200 A
Ø 0.5-4.0 mm

TBi SR 26



TBi SR 26 HD (FX) vodeno hlađenje

60% (10 min.)
AC: 160 A
DC: 230 A
Ø 0.5-4.0 mm

TBi SR 26 HD

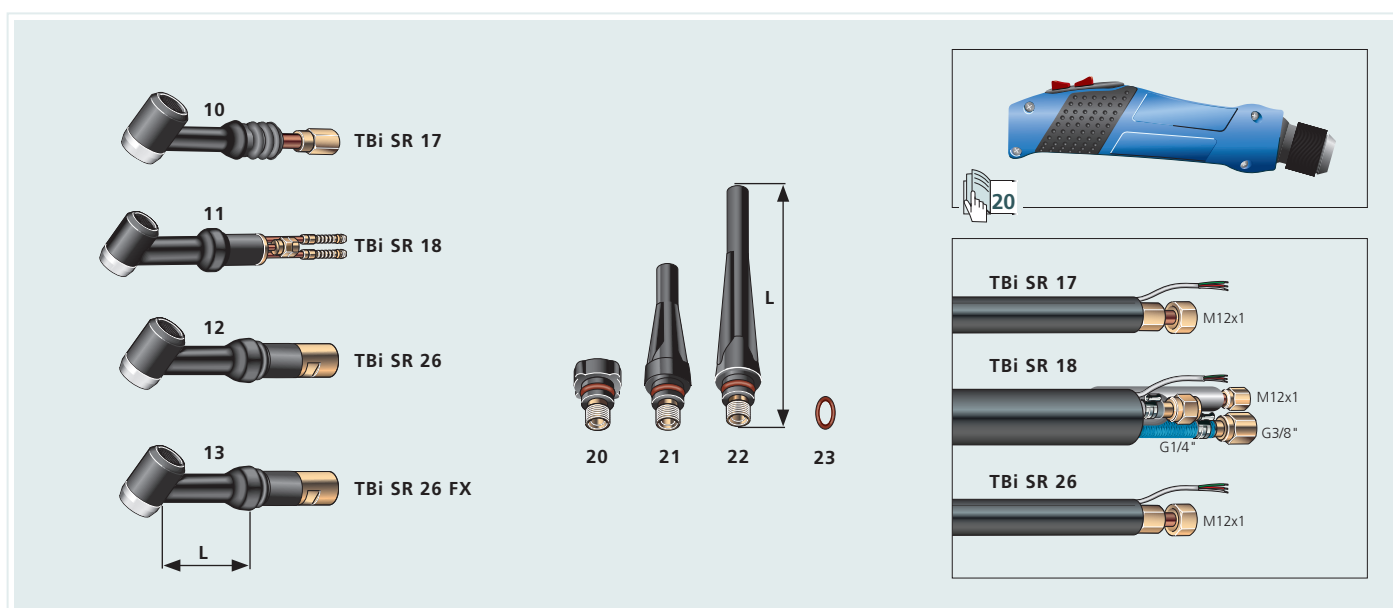

Rezervni dijelovi

10	Tijelo gorionika	SR 17		L = 50 mm	405P170700
10	Tijelo gorionika	SR 17 FX	<i>Fleksibilno</i>	L = 50 mm	403P170700
11	Tijelo gorionika	SR 18		L = 50 mm	405P180702
11	Tijelo gorionika	SR 18 FX	<i>Fleksibilno</i>	L = 50 mm	403P180702
12	Tijelo gorionika	SR 26		L = 50 mm	405P260702
13	Tijelo gorionika	SR 26 FX	<i>Fleksibilno</i>	L = 50 mm	403P260702
20	Kapa	Kratka		L = 24 mm	57Y04 402P170100
21	Kapa	Srednje		L = 58 mm	57Y05 402P170150
22	Kapa	Duga		L = 140 mm	57Y02 402P170200
23	O - Ring				98W18 365P200096

Potrošni materijal

B	Izolator	<i>Malo plinsko sito</i>	402P956100
▶ C	Izolator	<i>Standard</i>	18CG 403P171000
D	Izolator	<i>Plinsko sito</i>	54N01 401P181100
E	Adapter	<i>Jumbo plinsko sito</i>	54N63 401P171105

▶ = Standard

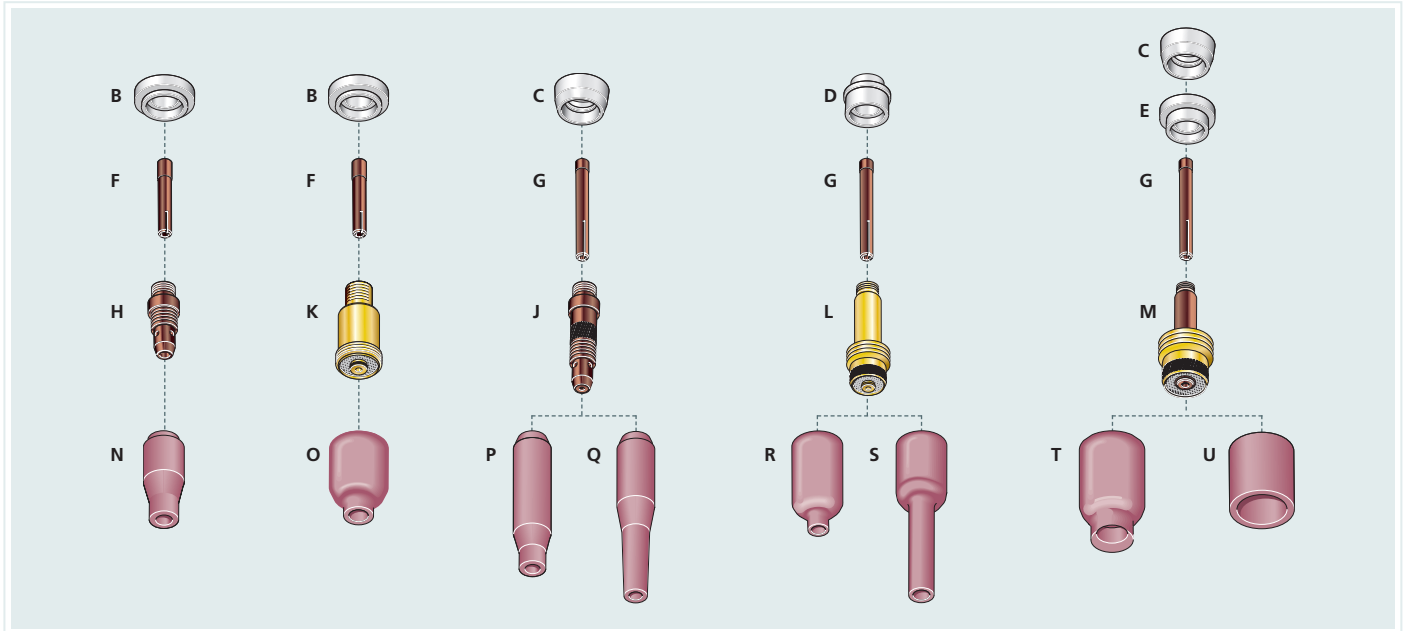

	Ø 0.5 mm Ø 0.020"	Ø 1.0 mm Ø 0.040"	Ø 1.6 mm Ø 1/16"	Ø 2.0 mm	Ø 2.4 mm Ø 3/32"	Ø 3.0 mm	Ø 3.2 mm Ø 1/8"	Ø 4.0 mm Ø 5/32"
--	----------------------	----------------------	---------------------	----------	---------------------	----------	--------------------	---------------------

Držači wolfram elektrode

F	Kratki L=29.3 mm	-	10N22S 402P10N22S	10N23S 402P10N23S	-	10N24S 402P10N24S	-	10N25S 402P10N25S	-
▶ G	Standard L=50.0 mm	10N21 402P170499	10N22 402P170500	10N23 402P170502	-	10N24 402P170503	-	10N25 402P170504	54N20 402P170505

Nosači wolfram elektrode

H	Kratki L=24.5 mm	-	Ø 1.0-1.6 mm 17CB22 402P17CB22		Ø 2.0-2.4 mm 17CB23 402P17CB23		Ø 3.0-3.2 mm 17CB24 402P17CB24		-
▶ J	Standard L=47.0 mm	-	Ø 0.5 - 1.6 mm 10N31 401P180999		Ø 2.0-2.4 mm 10N32 401P181000		Ø 3.0-3.2 mm 10N28 401P181001		406488 401P181002

Plinsko sito

K	Kratko L=27.0 mm	-	-	-	-	-	-	-	-
L	Standard L=50.0 mm	-	45V24 401P181299	45V25 401P181300	Ø 2.0-2.4 mm 45V26, 401P181301		Ø 3.0-3.2 mm 45V27, 401P181302		45V28 401P181303
M	Jumbo L=50.0 mm	-	45V0204 401P181350	45V116 401P181351	Ø 2.0-2.4 mm 45V64, 401P181352		Ø 3.0-3.2 mm 995795, 401P181353		45V63 401P181354

	No. 4 Ø 6.5 mm Ø 1/4"	No. 5 Ø 8.0 mm Ø 5/16"	No. 6 Ø 9.5 mm Ø 3/8"	No. 7 Ø 11 mm Ø 7/16"	No. 8 Ø 12.5 mm Ø 1/2"	No. 10 Ø 16 mm Ø 5/8"	No. 11 Ø 17.5 mm Ø 11/16"	No. 12 Ø 19 mm Ø 3/4"	Ø 24.0 mm
--	-----------------------------	------------------------------	-----------------------------	-----------------------------	------------------------------	-----------------------------	---------------------------------	-----------------------------	-----------

Keramičke sapnice

N	Kratka L=30.0 mm	13N08 401P201106	13N09 401P201107	13N10 401P201108	13N11 401P201109	13N12 401P201110	13N13 401P201111	-	-	-
O	Kratka plinska sap. L=25.5 mm	53N58 401P201400	53N59 401P201401	53N60 401P201402	53N61 401P201403	53N61S 401P201404	-	-	-	-
▶ P	Standard L=47.0 mm	10N50 401P170907	10N49 401P170908	10N48 401P170909	10N47 401P170910	10N46 401P170911	10N45 401P170912	-	10N44 401P170913*-	-
Q	Standard, L L=76.0 mm	10N50L 401P170923	10N49L 401P170914	10N48L 401P170915	10N47L 401P170916	-	-	-	-	-
R	Plinska sapnica L=42.0 mm	54N18 401P222200	54N17 401P222201	54N16 401P222202	54N15 401P222203	54N14 401P222204	-	54N19 401P222206	-	-
S	Plinska sapnica, L L=76.0 mm	54N18 L 401P222211	54N17 L 401P222207	54N16 L 401P222208	54N15 L 401P222209	54N14 L 401P222210	-	-	-	-
T	Jumbo plin. sapn. L=48.0 mm	-	-	57N75 401P201451	-	57N74 401P201452	53N88 401P222250	-	53N87 401P222251	53N89-L 401P222253
U	Jumbo plin. sap. (kratka), L=34.0mm	-	-	-	-	-	-	-	-	53N89 401P222252

* L=50.0 mm

▶ = Standard



MultiLock model

Gorionik TM 125



+ Glava
MultiLock 9/20
60% (10 min.)
AC: 80 A
DC: 110 A
Ø 0.5-2.4 mm



+ Glava
MultiLock 17/18/26
60% (10 min.)
AC: 100 A
DC: 140 A
Ø 1.0-2.4 mm

Gorionik TM 250



+ Glava
MultiLock 9/20
100% (10 min.)
AC: 160 A
DC: 220 A
Ø 0.5-3.2 mm



+ Glava
MultiLock 17/18/26
100% (10 min.)
AC: 225 A
DC: 320 A
Ø 1.0-4.0 mm

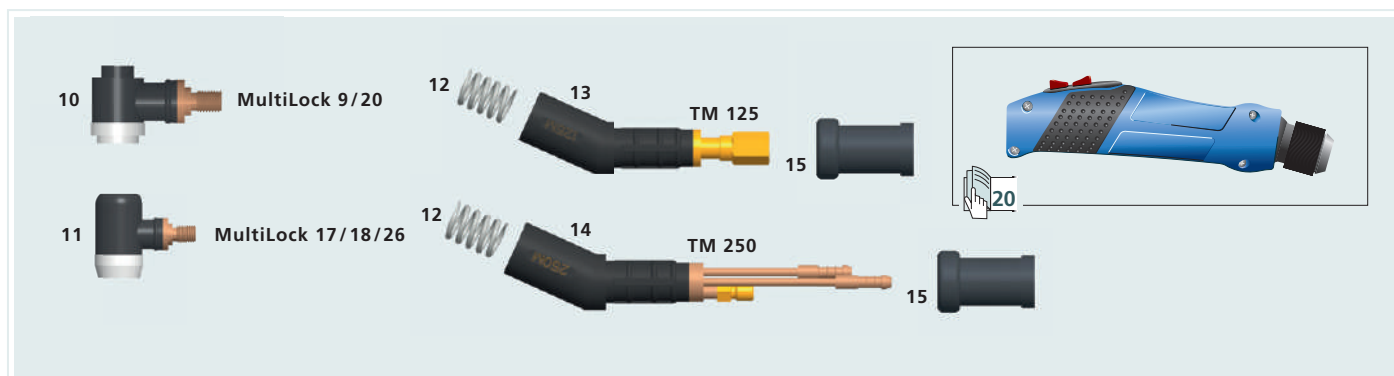

Rezervni dijelovi

10	Glava gorionika	MultiLock 9/20	402P550002
11	Glava gorionika	MultiLock 17/18/26	402P550003
12	Dodavač		402P550004
13	Tijelo gorionika	TM 125	402P550001
14	Tijelo gorionika	TM 250	402P600001
15	Prednji nastavak		402P600015



Kombinacija sa standardnim TBi dijelovima.





TBi XCT 200W
 Vodeno hlađenje
 100% (10 min.)
 AC: 175A
 DC: 250A
 Ø 1.6-4.0 mm



TBi XCT 400W
 Vodeno hlađenje
 100% (10 min.)
 AC: 315A
 DC: 450A
 Ø 1.6-4.0mm

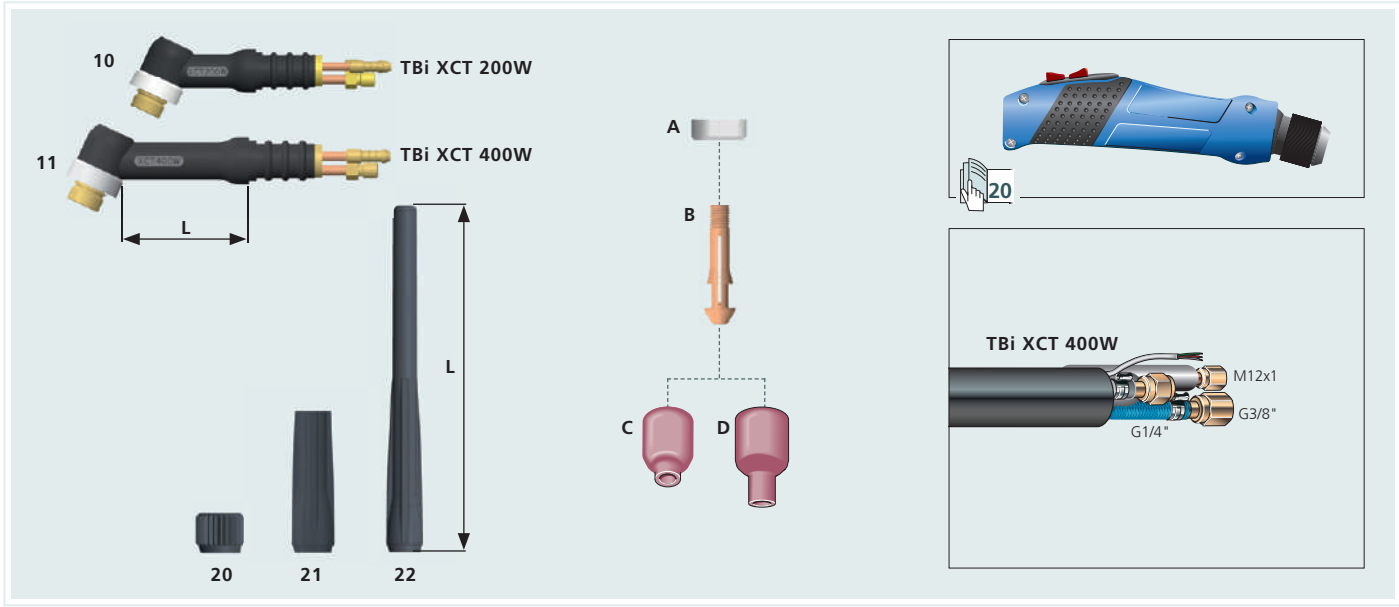

Ersatzteile / Spare parts / Pièces de rechange

10	Tijelo gorionika	XCT 200W	L = 32 mm	405PX20700
11	Tijelo gorionika	XCT 400W	L = 52 mm	405PX40700
20	Kapa	Kratka	L = 13 mm	402PX40600
21	Kapa	Srednje	L = 50 mm	402PX40650
22	Kapa	Duga	L = 145 mm	402PX40700
A	Izolator			401PX40700

	Ø 1.6 mm Ø 1/16"	Ø 2.4 mm Ø 3/32"	Ø 3.2 mm Ø 1/8"	Ø 4.0 mm Ø 5/32"
--	---------------------	---------------------	--------------------	---------------------

Držači Wolfram elektrode

▶ B	L = 44.0 mm	-	-	-	-
		401PX40501	401PX40502	401PX40503	401PX40504

	No. 4 Ø 6.5 mm Ø 1/4"	No. 5 Ø 8.0 mm Ø 5/16"	No. 6 Ø 9.5 mm Ø 3/8"	No. 7 Ø 11 mm Ø 7/16"	No. 8 Ø 12.5 mm Ø 1/2"	No. 10 Ø 16 mm Ø 5/8"
--	-----------------------------	------------------------------	-----------------------------	-----------------------------	------------------------------	-----------------------------

Keramičke sapnice

▶ C	L = 25.5 mm	53N58 401P201400	53N59 401P201401	53N60 401P201402	53N61 401P201403	53N61S 401P201404	- 401P201409
▶ D	L, L = 35.0 mm	53N58L 401P201408	53N59L 401P201405	53N60L 401P201406	53N61L 401P201407	-	- 401P201410

▶ = Standard

TBi SR 24G , TBi SR 24W

 <p>TBi SR 24G / TBi SR 24W</p>	TBi SR 24G <i>Plinsko (zračno) hlađenje</i> 60% (10 min.) AC: 80 A DC: 110 A Ø 0.5-1.6 mm	TBi SR 24W (FX) <i>Vodeno hlađenje</i> 100% (10 min.) AC: 100A DC: 140 A Ø 0.5-2.4 mm
--	---	---

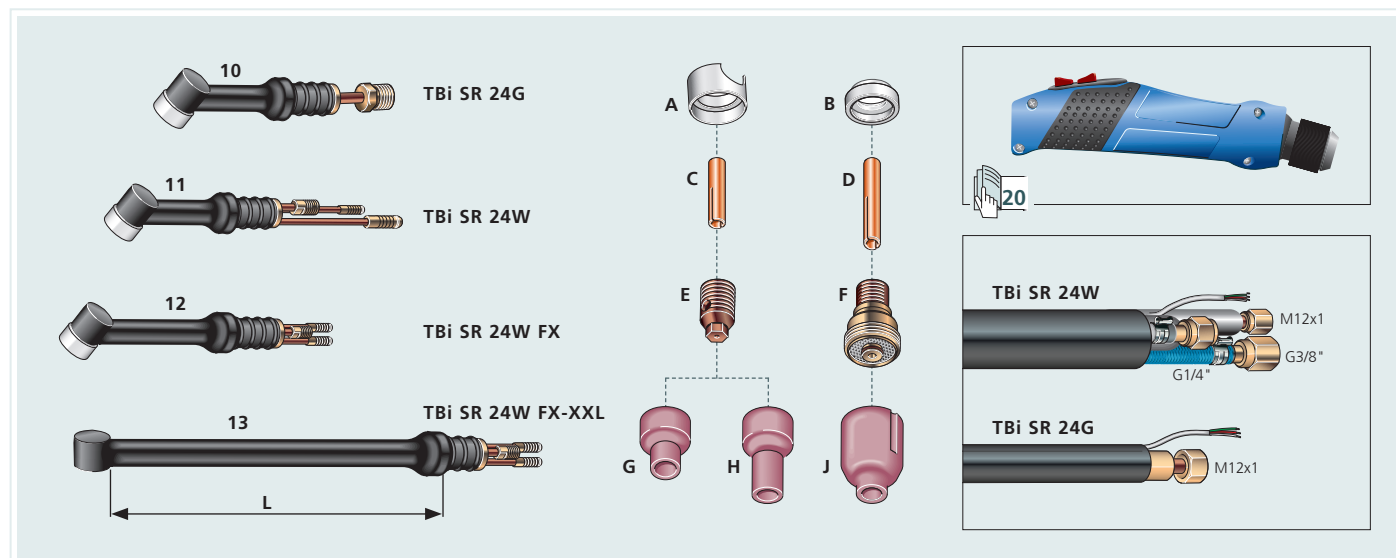

Ersatzteile / Spare parts / Pièces de rechange

10	Tijelo gorionika	SR 24G		L = 50 mm	405P240800
11	Tijelo gorionika	SR 24W		L = 50 mm	405P240850
12	Tijelo gorionika	SR 24W FX (Standard)	Fleksibilno	L = 65 mm	403P240700
12	Tijelo gorionika	SR 24W FX-L	Fleksibilno	L = 90 mm	403P240750
12	Tijelo gorionika	SR 24W FX-XL	Fleksibilno	L = 115 mm	403P240701
13	Tijelo gorionika	SR 24W FX-XXL	Fleksibilno	L = 290 mm	403P240770
▶ A	Izolator				53N22 401P240700*
B	Izolator		Plinsko sito		53N66 401P240701*
B	Izolator	SR 24W FX-XXL	Plinsko sito		401P240702

	Ø 0.5 mm Ø 0.020"	Ø 1.0 mm Ø 0.040"	Ø 1.6 mm Ø 1/16"	Ø 2.4 mm Ø 3/32"
--	----------------------	----------------------	---------------------	---------------------

Držači Wolfram elektrode

▶ C	L = 14.0 mm	53N15 401P240500	53N16 401P240501	53N14 401P240502	24C332 401P240505
D	Plinske spanice, L = 23.0 mm	-	53N63 401P240802	53N64 401P240803	24GLC332 401P240805

Nosači Wolfram elektrode

▶ E	L = 12.0 mm	53N17 401P241000	53N18 401P241001	53N19 401P241002	24CB332 401P241003
-----	-------------	---------------------	---------------------	---------------------	-----------------------

Plinsko sito

F	L = 21.5 mm	-	45V42 401P201300	45V43 401P201301	45V44 401P201302
---	-------------	---	---------------------	---------------------	---------------------

	No. 4 Ø 6.5 mm Ø 1/4"	No. 5 Ø 8.0 mm Ø 5/16"	No. 6 Ø 9.5 mm Ø 3/8"	No. 7 Ø 11 mm Ø 7/16"	No. 8 Ø 12.5 mm Ø 1/2"
--	-----------------------------	------------------------------	-----------------------------	-----------------------------	------------------------------

Keramičke sapnice

▶ G	Standard, L = 16.5 mm	53N24 401P240900	53N25 401P240901	53N27 401P240902	-	-
H	Standard, duga, L = 29 mm	53N24L 401P240903	-	53N26L 401P240904	-	-
J	Plinsko sito L=25.5 mm	53N58 401P201400	53N59 401P201401	53N60 401P201402	53N61 401P201403	53N61S 401P201404

▶ = Standard Nije kompatibilno sa tijelom gorionika SR 24W FX - XXL



TBi SR 25G FX / TBi SR 25W FX

TBi SR 25G FX

Plinsko (zračno) hlađenje

60% (10 min.)
AC: 80 A
DC: 110 A
Ø 0.5-2.4 mm

TBi SR 25W FX

Vodeno hlađenje

100% (10 min.)
AC: 100A
DC: 140 A
Ø 0.5-3.2 mm

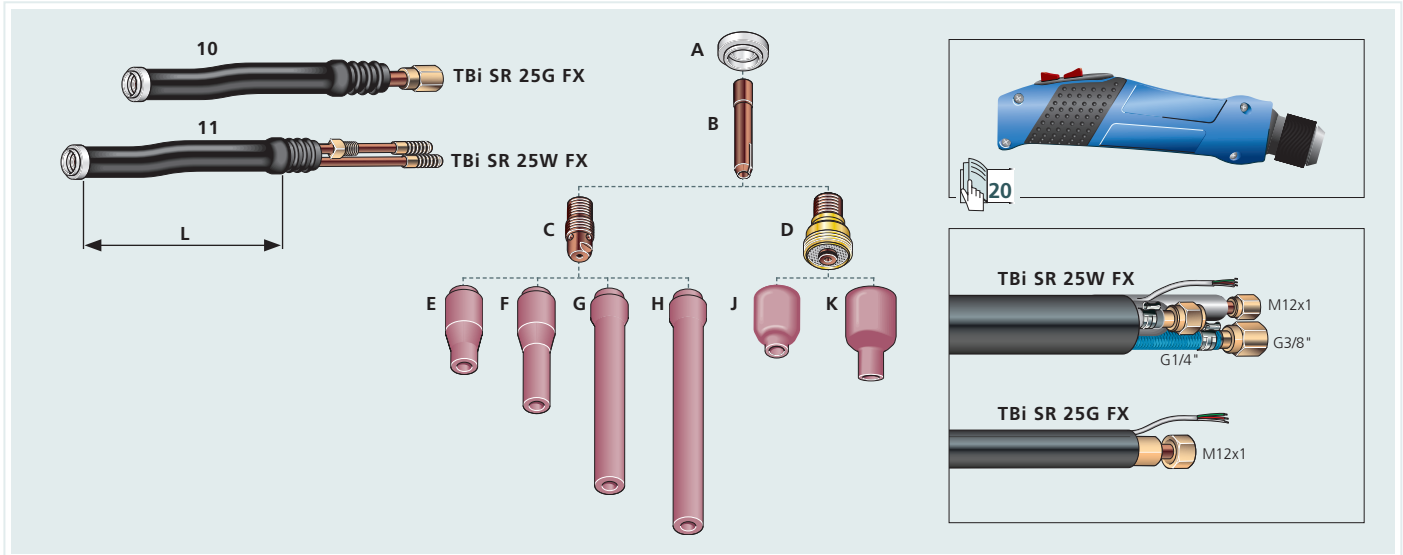

Rezervni dijelovi

10	Tijelo gorionika	SR 25G FX	Fleksibilno	L = 120 mm	401P250200
11	Tijelo gorionika	SR 25W FX (Standard)	Fleksibilno	L = 120 mm	401P251200
11	Tijelo gorionika	SR 25W FX-L	Fleksibilno	L = 300 mm	401P251201
A	Izolator				401P250800

	Ø 0.5 mm Ø 0.020"	Ø 1.0 mm Ø 0.040"	Ø 1.6 mm Ø 1/16"	Ø 2.0 mm	Ø 2.4 mm Ø 3/32"	Ø 3.0 mm	Ø 3.2 mm Ø 1/8"	
Držači Wolfram elektrode								
▶ B	Standard, L = 25.4 mm	13N20 401P200599	13N21 401P200600	13N22 401P200601	- 401P200604	13N23 401P200602	- 401P200605	13N24 401P200603
Nosači Wolfram elektrode								
▶ C	L = 20.6 mm	Ø 0.5 - 1.6 mm 13N27 401P201001		Ø 2.0 - 2.4 mm 13N28 401P201002		Ø 3.0 - 3.2 mm 13N29 401P201003		
Plinsko sito								
D	L = 21.5 mm	- -	45V42 401P201300	45V43 401P201301	Ø 2.0 - 2.4 mm 45V44 401P201302		Ø 3.0 - 3.2 mm 45V45 401P201303	

	No. 3 Ø 5.0 mm Ø 3/16"	No. 4 Ø 6.5 mm Ø 1/4"	No. 5 Ø 8.0 mm Ø 5/16"	No. 6 Ø 9.5 mm Ø 3/8"	No. 7 Ø 11 mm Ø 7/16"	No. 8 Ø 12.5 mm Ø 1/2"	No. 10 Ø 16 mm Ø 5/8"	
Keramičke sapnice								
▶ E	Standard, L = 30.0 mm	- -	13N08 401P201106	13N09 401P201107	13N10 401P201108	13N11 401P201109	13N12 401P201110	13N13 401P201111
F	Standard, L, L = 48.0 mm	796F70 401P201115	796F71 401P201116	796F72 401P201117	796F73 401P201118	- -	- -	- -
G	Standard, XL, L = 63.0 mm	- -	796F75 401P201126	796F76 401P201127	796F77 401P201128	- -	- -	- -
H	Standard, XXL, L = 89.0 mm	- -	796F79 401P201136	- -	- -	- -	- -	- -
J	Plinsko sito, L = 25.5 mm	- -	53N58 401P201400	53N59 401P201401	53N60 401P201402	53N61 401P201403	53N61S 401P201404	- -
K	Plinsko sito, L, L = 35.0 mm	- -	53N58L 401P201408	53N59L 401P201405	53N60L 401P201406	53N61L 401P201407	- -	- -

▶ = Standard



TBi AW 424

Vodeno hlađenje
100% (10 min.)
AC: 280A
DC: 400A
Ø 1.0-4.0 mm



TBi AW 427

Vodeno hlađenje
100% (10 min.)
AC: 350A
DC: 500A
Ø 2.4-8.0 mm

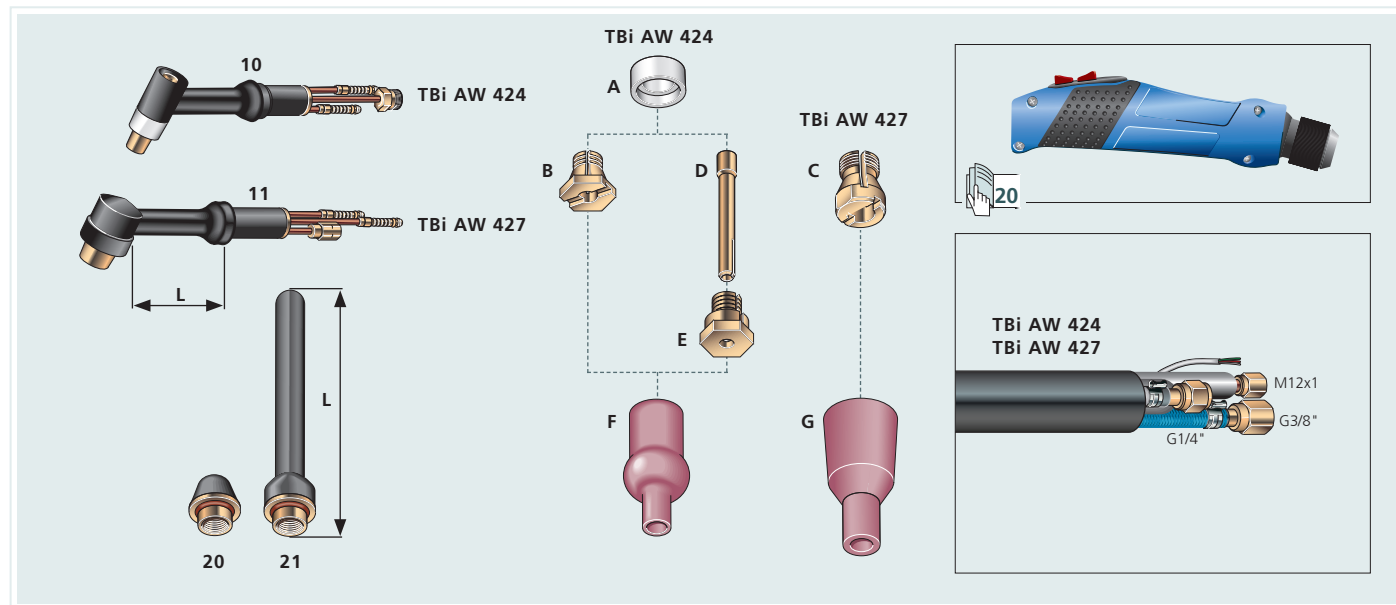

Rezervni dijelovi

10	Tijelo gorionika	AW 424	L = 55 mm	404P240702
11	Tijelo gorionika	AW 427	L = 55 mm	404P270702
20	Kapa	Kratka	L = 16 mm	411-30 404P240100
21	Kapa	Duga	L = 101 mm	411-70 404P240200
A	Izolator	AW 424	200 NG	404P280300

	Ø 1.0 mm Ø 0.040"	Ø 1.6 mm Ø 1/16"	Ø 2.4 mm Ø 3/32"	Ø 3.2 mm Ø 1/8"	Ø 4.0 mm Ø 5/32"	Ø 4.8 mm Ø 3/16"	Ø 6.4 mm Ø 1/4"	Ø 8.0 mm Ø 5/16"
--	----------------------	---------------------	---------------------	--------------------	---------------------	---------------------	--------------------	---------------------

Stezna čahura

B	AW 424, L = 10.5 mm	-	221.00 404P240501	222.00 404P240502	223.00 404P240503	224.00 404P240504	-	-	-
C	AW 427, L = 17 mm	-	-	223-07 404P270499	224-07 404P270500	225-07 404P270501	226-07 404P270502	227-07 404P270503	228-07 404P270504

Držaci Wolfram elektrode

D	AW 424, L = 59 mm	964.01 404P240602	965.01 404P240603	966.01 404P240604	967.01 404P240605	968.01 404P240606	-	-	-
---	----------------------	----------------------	----------------------	----------------------	----------------------	----------------------	---	---	---

Nosači Wolfram elektrode

E	AW 424, L = 10.5 mm	961.41 404P240902	961.51 404P240903	961.61 404P240904	961.71 404P240905	961.81 404P240906	-	-	-
---	------------------------	----------------------	----------------------	----------------------	----------------------	----------------------	---	---	---

	No. 4 Ø 6.5 mm Ø 1/4"	No. 5 Ø 8.0 mm Ø 5/16"	No. 6 Ø 9.5 mm Ø 3/8"	No. 7 Ø 11 mm Ø 7/16"	No. 8 Ø 12.5 mm Ø 1/2"	No. 9 Ø 14 mm Ø 9/16"	No. 10 Ø 16 mm Ø 5/8"	Ø 18 mm
--	-----------------------------	------------------------------	-----------------------------	-----------------------------	------------------------------	-----------------------------	-----------------------------	---------

Keramičke sapnice

F	Standard, L = 44.0 mm	130-00 404P241100	131-00 404P241101	132-00 404P241102	133-00 404P241103	134-00 404P241104	135-00 404P241105	136-00 404P241106	- 404P241108
G	Standard, L = 54.0 mm	-	141-00 404P271100	142-00 404P271101	143-00 404P271102	144-00 404P271103	-	145-00 404P271104	-



TBi SR 400

Vodeno hlađenje

100% (10 min.)
AC: 315A
DC: 450A
Ø 1.0-4.8 mm

TBi SR 400

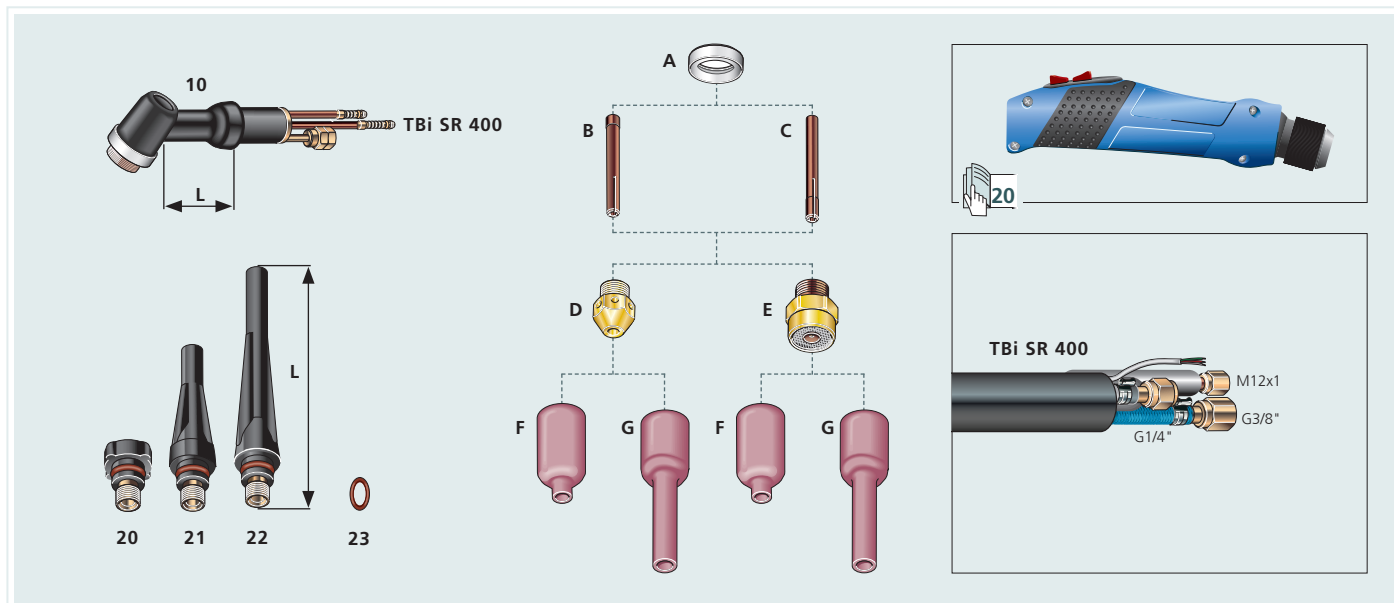

Rezervni dijelovi

10	Tijelo gorionika	SR 400	L = 50 mm	405P400802
20	Kapa	Kratka	L = 24 mm	57Y04 402P170100
21	Kapa	Srednje	L = 58 mm	57Y05 402P170150
22	Kapa	Duga	L = 140 mm	57Y02 402P170200
23	O - ring			98W18 365P200096
A	Izolator			18NG 405P400001

	Ø 1.0 mm Ø 0.040"	Ø 1.6 mm Ø 1/16"	Ø 2.4 mm Ø 3/32"	Ø 3.2 mm Ø 1/8"	Ø 4.0 mm Ø 5/32"	Ø 4.8 mm Ø 3/16"
Držač Wolfram elektrode						
▶ B	Standard, L = 50 mm	10N22 402P170500	10N23 402P170502	10N24 402P170503	10N25 402P170504	54N20 402P170505
C	Heavy duty, L = 50 mm	-	-	-	10N25HD 405P400504	54N20HD 405P400505
Nosač Wolfram elektrode						
▶ D	L = 19.5 mm	Ø 1.0-3.2 mm 405P401000		Ø 3.2-4.8 mm 405P401001		
Plinsko sito						
E	L = 21.3 mm	18GL04 405P401301	18GL16 405P401302	18GL32 405P401303	18GL18 405P401304	18GL53 405P401305
						18GL36 405P401306

	No. 4 Ø 6.5 mm Ø 1/4"	No. 5 Ø 8.0 mm Ø 5/16"	No. 6 Ø 9.5 mm Ø 3/8"	No. 7 Ø 11 mm Ø 7/16"	No. 8 Ø 12.5 mm Ø 1/2"	No. 11 Ø 17.5 mm Ø 11/16"
Keramičke sapnice						
▶ F	Standard, L = 42.0 mm	54N18 401P222200	54N17 401P222201	54N16 401P222202	54N15 401P222203	54N14 401P222204
G	Standard, L, L=76.0 mm	54N18 L 401P222211	54N17 L 401P222207	54N16 L 401P222208	54N15 L 401P222209	54N14 L 401P222210
						-

▶ = Standard



Drške i moduli

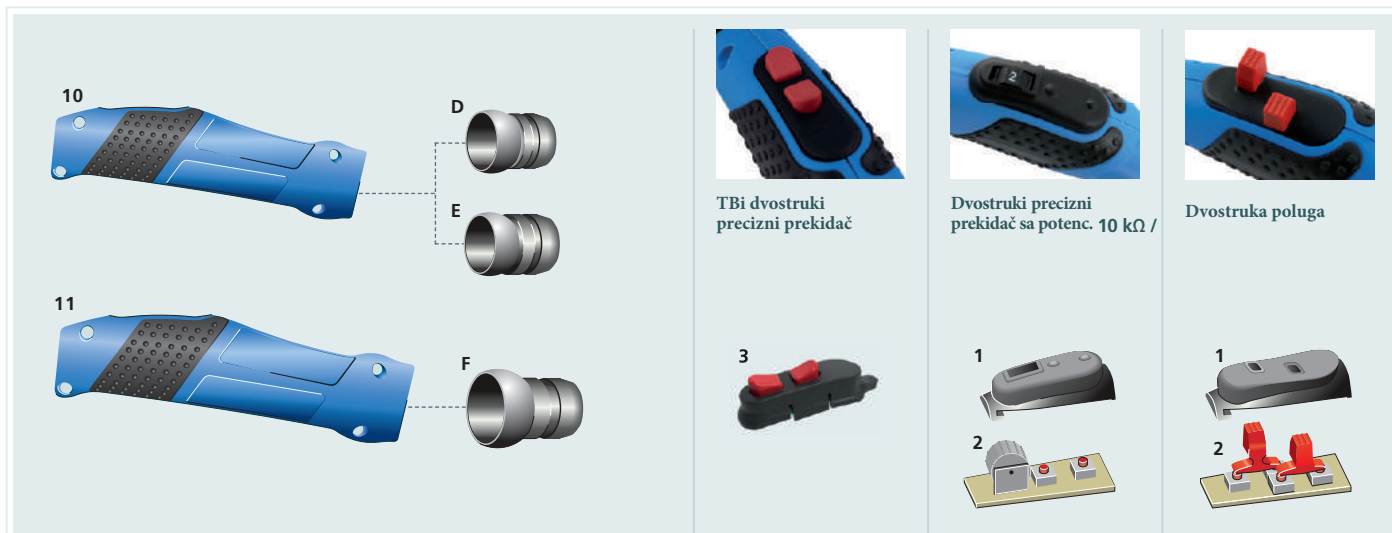

Moduli			
1 Zaštita	-	401P102023	401P102038
2 PC - Ploča	-	384P101035	384P101050
3 PSD cpl. modul	401P101090	-	-

Ručke uključujući PSD

10 Male ručke, zamjene za gorionike samo sa PSD. SR 9, SR 17, SR 20, SR 21, SR 24, XCT 200 W, XCT 400 W, TM125	401P101012	-	-
11 Velike ručke, zamjene za gorionike samo sa PSD SR 18, SR 26, AW 424, TM250	401P101512	-	-

Ručke uključujući module

10 Male ručke SR 9, SR 17, SR 20, SR 21, SR 24, SR 25, XCT 400 W	-	401P101020	401P101030
11 Velike ručke SR 18, SR 26, SR 400, AW 424, AW 427	-	401P101520	401P101530

Rezervni dijelovi

D Kuglasti zglob	SR 9, 17, 24 G, 25 G	401P102026
E Kuglasti zglob	SR 20, 21, 24 W, 25 W, XCT 400W	401P102029
F Kuglasti zglob	SR 18, 26, 400, AW 424, 427	401P102032

Tijela gorionika i oprema





TBi SR 12

Vodeno hlađenje

100% (10 min.)
AC: 350A
DC: 500A
Ø 2.4-6.4 mm

TBi SR 12

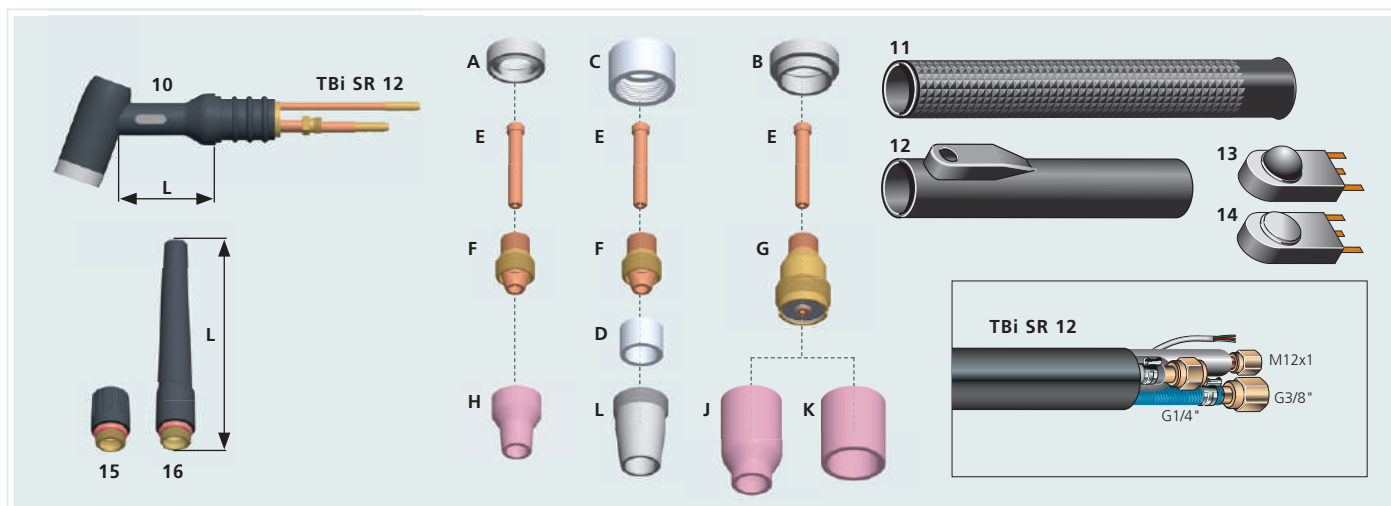

Rezervni dijelovi

10	Tijelo gorionika	SR 12	L = 60 mm	405P120800
11	Drška cijevi			85WP13 405P120900
12	Prekidač			401P120600
13	Prekidač	Okruglo		385P033009
14	Prekidač	Ravno		385P233009
15	Kapa	Kratka	L = 31 mm	56Y45 405P120100
16	Kapa	Duga	L = 115 mm	56Y44 405P120200
A	Izolator	Standard		12NG 405P120300
B	Izolator	Plinska sapnica		12GLG 405P120301
C	Izolator	Metalne dizne		12MNG 405P120302
D	Izolacijski rukavac			85Z99 405P120303

	Ø 2.4 mm Ø 3/32"	Ø 3.2 mm Ø 1/8"	Ø 4.0 mm Ø 5/32"	Ø 4.8 mm Ø 3/16"	Ø 6.4 mm Ø 1/4"
--	---------------------	--------------------	---------------------	---------------------	--------------------

Držak Wolfram elektrode

E	L = 60,2 mm	85Z15 405P120502	85Z16 405P120503	85Z17 405P120504	85Z18 405P120505	85Z19 405P120506
---	-------------	---------------------	---------------------	---------------------	---------------------	---------------------

Nosač Wolfram elektrode

F	Ø 2.4-6.4 mm 11WP65, 405P121000				
---	------------------------------------	--	--	--	--

Plinske spanice

G	11GL32 405P121302	11GL18 405P121303	11GL53 405P121304	11GL36 405P121305	- 405P121306
---	----------------------	----------------------	----------------------	----------------------	-----------------

	No. 4 Ø 6.5 mm Ø 1/4"	No. 5 Ø 8.0 mm Ø 5/16"	No. 6 Ø 9.5 mm Ø 3/8"	No. 7 Ø 11 mm Ø 7/16"	No. 8 Ø 12.5 mm Ø 1/2"	No. 10 Ø 16 mm Ø 5/8"	No. 12 Ø 19 mm Ø 3/4"	Ø 24 mm
--	-----------------------------	------------------------------	-----------------------------	-----------------------------	------------------------------	-----------------------------	-----------------------------	---------

Keramičke dizne

H	Standard, L = 32 mm	14N57 401P101700	14N58 401P101701	14N59 401P101702	14N60 401P101703	14N61 401P101704	-	-	-
J	Jumbo plin.dizne L = 48 mm	-	-	57N75 401P201451	-	57N74 401P201452	53N88 401P222250	53N87 401P222251	53N89-L 401P222253
K	Jumbo plin. dizne (kratka), L = 34 mm	-	-	-	-	-	-	-	53N89 401P222252

Metalne dizne

L	Standard, L = 40.7 mm	-	-	-	-	86Z02 405P120701	86Z03 405P120702	86Z06 405P120703	-
---	--------------------------	---	---	---	---	---------------------	---------------------	---------------------	---

► = Standard

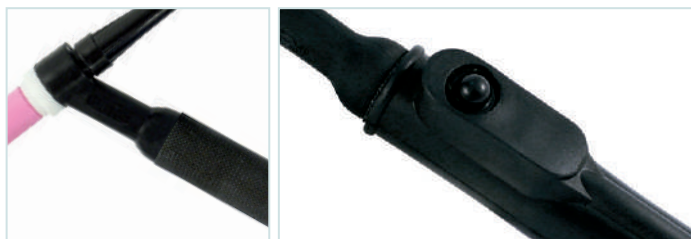

Drške cijevi i prekidači

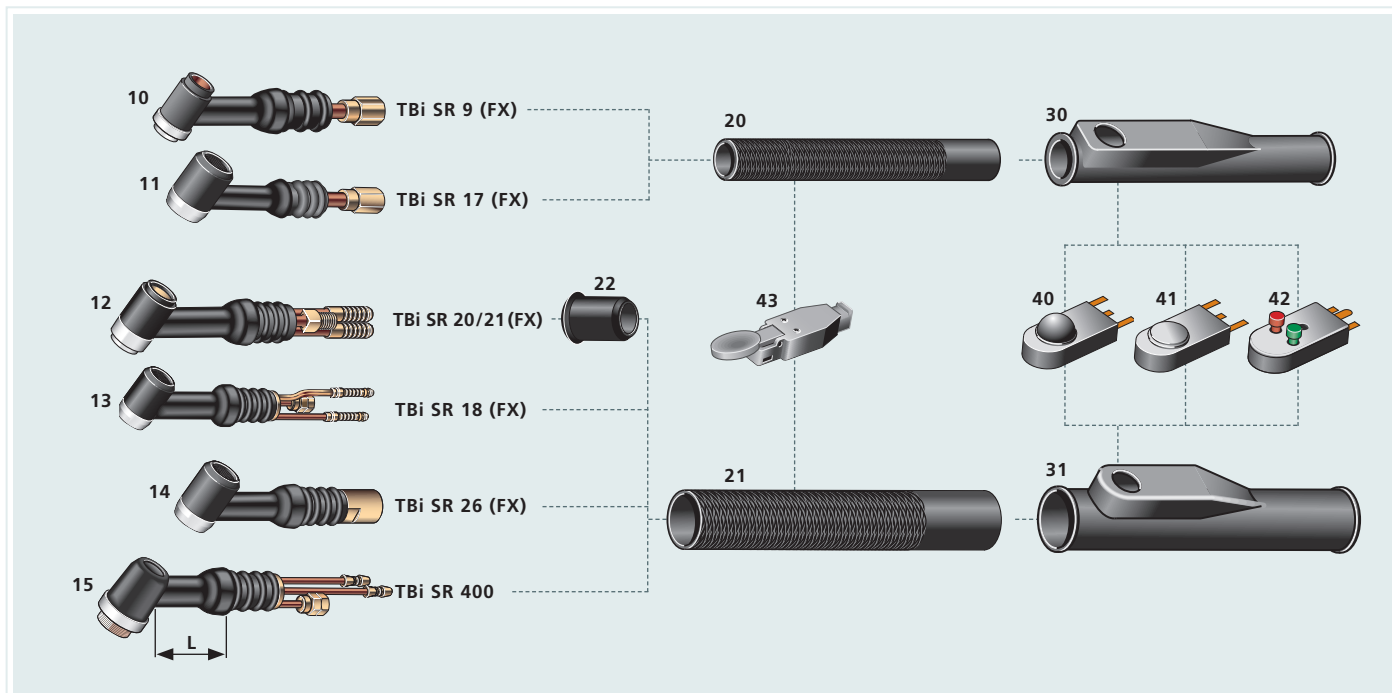

Rezervni dijelovi

10	Tijelo gorionika	SR 9		L = 35 mm	405P090800
10	Tijelo gorionika	SR 9 FX	Fleksibilno	L = 35 mm	403P090800
11	Tijelo gorionika	SR 17		L = 50 mm	405P170700
11	Tijelo gorionika	SR 17 FX	Fleksibilno	L = 50 mm	403P170700
12	Tijelo gorionika	SR 20		L = 35 mm	405P200800
12	Tijelo gorionika	SR 20 FX	Fleksibilno	L = 35 mm	403P200700
12	Tijelo gorionika	SR 21		L = 35 mm	405P210800
12	Tijelo gorionika	SR 21 FX	Fleksibilno	L = 65 mm	403P210700
12	Tijelo gorionika	SR 21 FX-L	Fleksibilno	L = 115 mm	403P210701
13	Tijelo gorionika	SR 18		L = 55 mm	405P180700*
13	Tijelo gorionika	SR 18 FX	Fleksibilno	L = 55 mm	403P180700*
14	Tijelo gorionika	SR 26		L = 50 mm	405P260700*
14	Tijelo gorionika	SR 26 FX	Fleksibilno	L = 50 mm	403P260700*
15	Tijelo gorionika	SR 400		L = 50 mm	405P400800*

Drške cijevi

20	Drška cijevi	SR 9, SR 17	D=20,5 mm / L=130 mm	402P171301
21	Drška cijevi	SR 18, SR 20, SR 26, SR 400	D=27,5 mm / L=154 mm	402P180801
22	Prednji dodatak	SR 20		401P201360

Boot prekidač

30	Boot prekidač	SR 9, SR 17		401P170600
31	Boot prekidač	SR 18, SR 20, SR 26, SR 400		402P180600

Prekidači

40	Prekidač		Okruglo	SW-1-B	385P033009
40	Crouzet prekidač		Okruglo	SW-1-B	385P333009
41	Prekidač		Ravni	SW-1-F	385P133009
42	Dvostruki prekidač		Crveno, Zeleno		385P033014
43	Termo prekidač				385P120002

* Nije kompaktilno sa TBi preciznim drškama

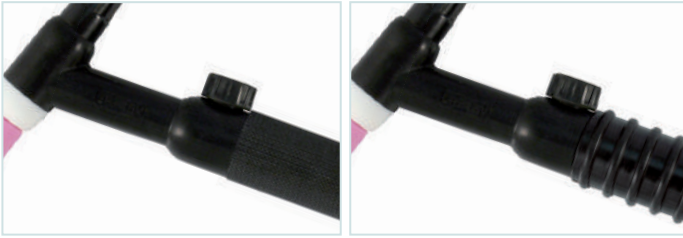

Drške cijevi za tijelo gorionika sa ventilom

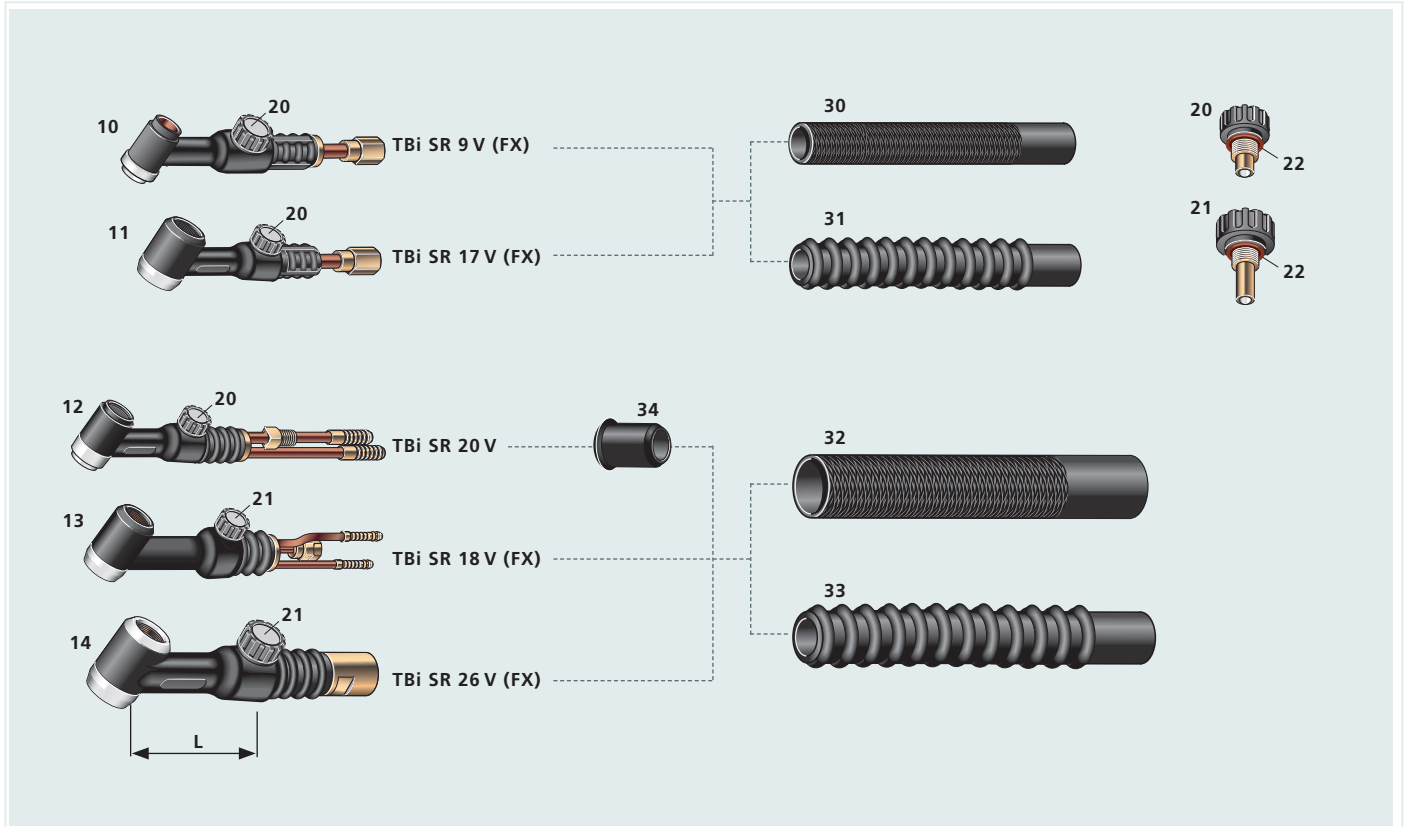

Rezervni dijelovi

10	Tijelo gorionika	SR 9 V		L = 50 mm	405P090850
10	Tijelo gorionika	SR 9 V FX	Fleksibilno	L = 50 mm	403P090900
11	Tijelo gorionika	SR 17 V		L = 50 mm	405P170800
11	Tijelo gorionika	SR 17 V FX	Fleksibilno	L = 50 mm	403P170800
12	Tijelo gorionika	SR 20 V		L = 50 mm	405P200850
13	Tijelo gorionika	SR 18 V		L = 70 mm	405P180750
13	Tijelo gorionika	SR 18 V FX	Fleksibilno	L = 65 mm	403P180800
14	Tijelo gorionika	SR 26 V		L = 65 mm	405P260800
14	Tijelo gorionika	SR 26 V FX	Fleksibilno	L = 65 mm	403P260800
20	Ventil	SR 9 V, SR 17 V, SR 20 V			405P172400
21	Ventil	SR 18 V, SR 26 V			405P262400
22	O - Ring				365P018047

Drške cijevi

▶	30	Glatka drška	SR 9 V, SR 17 V	D=20,5 mm / L= 130 mm	H 100	402P171301
	31	Rebrasta drška	SR 9 V, SR 17 V	D=20,5 mm / L= 130 mm	H 100R	402P179264
▶	32	Glatka drška	SR 18 V, SR 20 V, SR 26 V	D=27,5 mm / L= 154 mm	H 200	402P180801
	33	Rebrasta drška	SR 18 V, SR 20 V, SR 26 V	D=27,5 mm / L= 154 mm	H 200R	405P260801
	34	Prednji dodatak	SR 20 V	D=21,5 mm / L= 27 mm		401P201360

Oprema  11-19

▶ = Standard

Modeli sa nožnim prekidačem (oštricom)

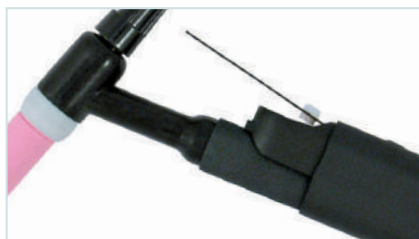

Modeli sa nožnim prekidačem

Plinsko (zračno) hlađenje



TBi SR 9 (FX)

60% (10 min.)
AC: 80 A
DC: 110 A
Ø 0.5-1.6 mm



TBi SR 17 (FX)

60% (10 min.)
AC: 100 A
DC: 140 A
Ø 0.5-2.4 mm

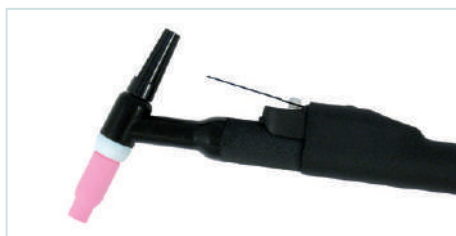

TBi SR 26 (FX)

60% (10 min.)
AC: 140 A
DC: 200 A
Ø 0.5-4.0 mm

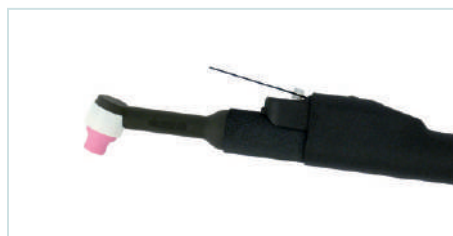

TBi SR 24G

60% (10 min.)
AC: 80 A
DC: 110 A
Ø 0.5-1.6 mm

Vodeno hlađenje

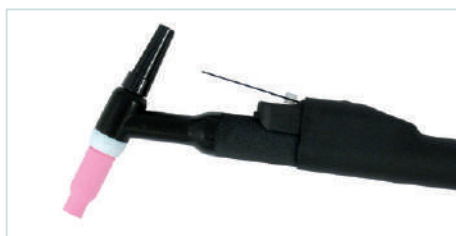

TBi SR 18 (FX)

100% (10 min.)
AC: 225 A
DC: 320 A
Ø 0.5-4.0 mm



TBi SR 20 (FX)

100% (10 min.)
AC: 160 A
DC: 220 A
Ø 0.5-3.2 mm



TBi SR 21 (FX)

100% (10 min.)
AC: 240 A
DC: 340 A
Ø 0.5-3.2 mm



TBi SR 400

100% (10 min.)
AC: 315 A
DC: 450 A
Ø 1.0-4.8 mm

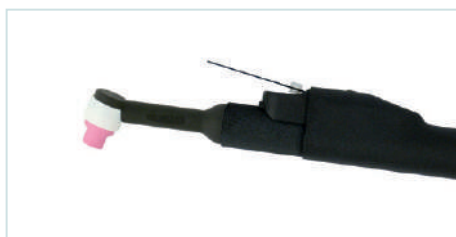

TBi SR 24W (FX)

100% (10 min.)
AC: 100 A
DC: 140 A
Ø 0.5-4.0 mm

Weitere Modelle auf Anfrage verfügbar /
Other models available on request /
Autres modèles disponibles sur demande

TBi SR 25G,
TBi SR 25W



Modeli sa nožnim prekidačem (oštricom)

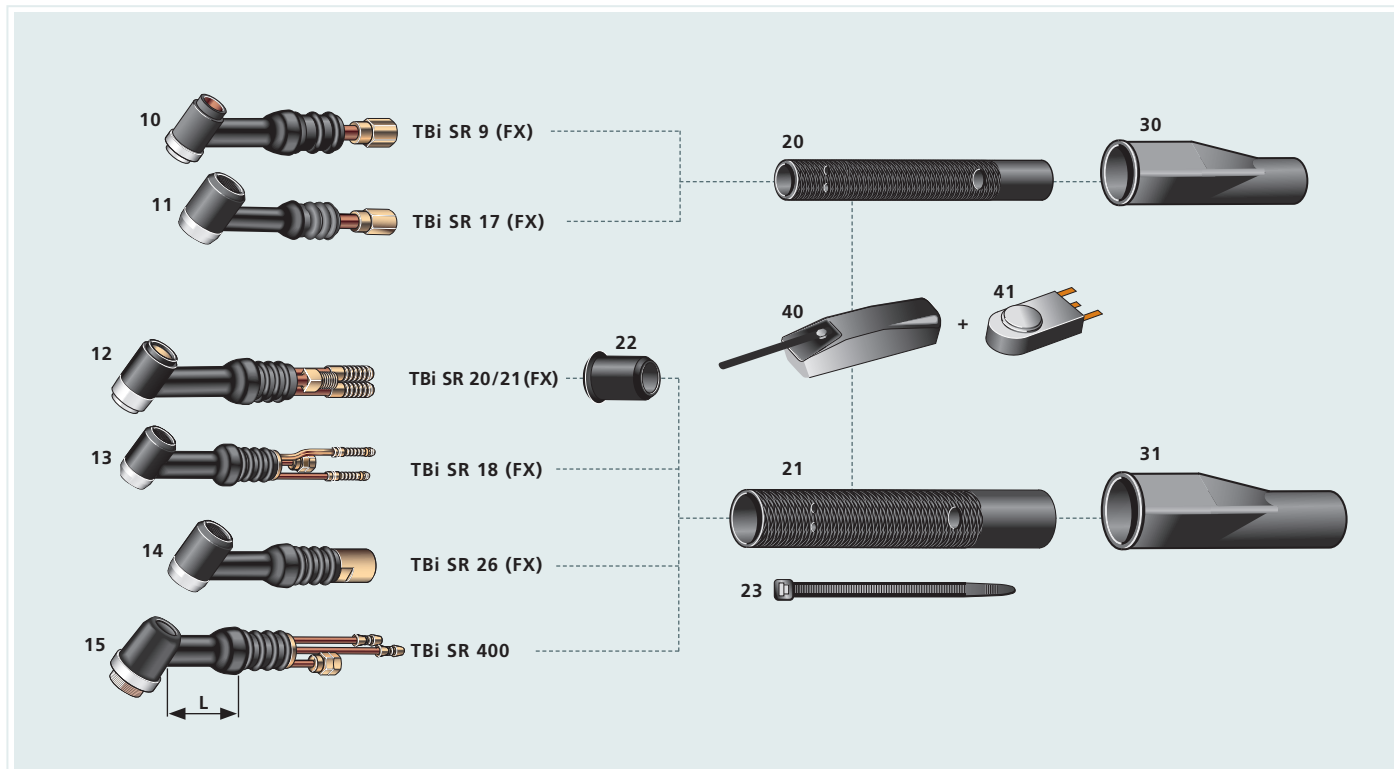

Rezervni dijelovi

10	Tijelo gorionika	SR 9		L = 35 mm	405P090800
10	Tijelo gorionika	SR 9 FX	Fleksibilno	L = 35 mm	403P090800
11	Tijelo gorionika	SR 17		L = 50 mm	405P170700
11	Tijelo gorionika	SR 17 FX	Fleksibilno	L = 50 mm	403P170700
12	Tijelo gorionika	SR 20		L = 35 mm	405P200800
12	Tijelo gorionika	SR 20 FX	Fleksibilno	L = 35 mm	403P200700
12	Tijelo gorionika	SR 21		L = 35 mm	405P210800
12	Tijelo gorionika	SR 21 FX	Fleksibilno	L = 65 mm	403P210700
12	Tijelo gorionika	SR 21 FX-L	Fleksibilno	L = 115 mm	403P210701
13	Tijelo gorionika	SR 18		L = 55 mm	405P180700*
13	Tijelo gorionika	SR 18 FX	Fleksibilno	L = 55 mm	403P180700*
14	Tijelo gorionika	SR 26		L = 50 mm	405P260700*
14	Tijelo gorionika	SR 26 FX	Fleksibilno	L = 50 mm	403P260700*
15	Tijelo gorionika	SR 400		L = 50 mm	405P400800*

Ručke cijevi

20	Ručke cijevi	SR 9, SR 17	D=20,5 mm / L= 130 mm	402P171302
21	Ručke cijevi	SR 18, SR 20, SR 26, SR 400	D=27,5 mm / L= 154 mm	402P180802
22	Prednji dodatak	SR 20		401P201360
23	Vezica za kabel			391P000069

Boot prekidač

30	Boot prekidač	SR 9, SR 17		401P102051
31	Boot prekidač	SR 18, SR 20, SR 26, SR 400		401P102052

Prekidač

40	Nožni prekidač (oštrica)			402P101002
41	Crouzet prekidač		Ravno, dugotrajno	SW-1-F 385P233009

* Nije kompatibilno sa TBi preciznim drškama

Oprema  11-19

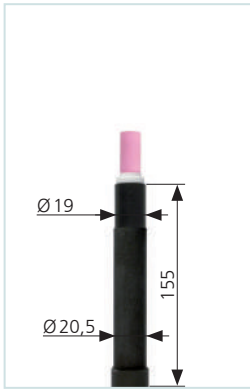

TBi SR 9 P (Aut)

Plinsko (zračno) hlađenje

60% (10 min.)
AC: 80 A
DC: 110 A
Ø 0.5-1.6 mm



TBi SR 18 P (Aut)

Vodeno hlađenje

100% (10 min.)
AC: 225 A
DC: 320 A
Ø 0.5-4.0 mm

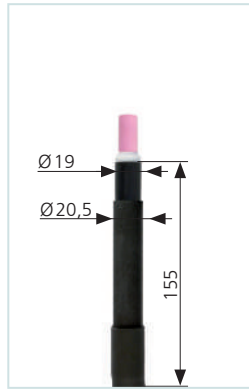

TBi SR 20 P (Aut)

Vodeno hlađenje

100% (10 min.)
AC: 105 A
DC: 140 A
Ø 0.5-3.2 mm



TBi SR 26 P (Aut)

Plinsko (zračno) hlađenje

60% (10 min.)
AC: 140 A
DC: 200 A
Ø 0.5-4.0 mm

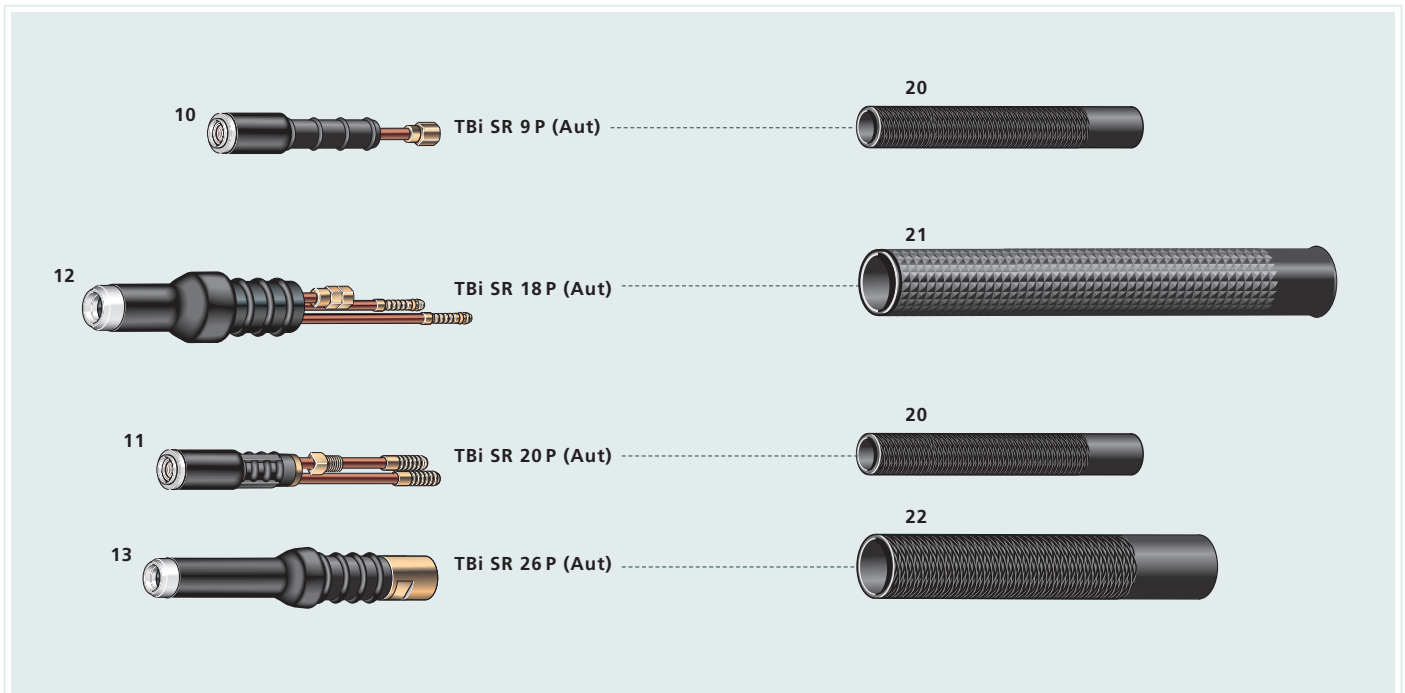

Rezervni dijelovi

10	Tijelo gorionika	SR 9 P (Aut)	405P090900
11	Tijelo gorionika	SR 20 P (Aut)	491P200001
12	Tijelo gorionika	SR 18 P (Aut)	491P180001
13	Tijelo gorionika	SR 26 P (Aut)	405P260900

Drška cijevi

▶ 20	Drška cijevi	SR 9 P (Aut), SR 20 P (Aut)	D=20,5 mm / L=130 mm	402P171301
▶ 21	Drška cijevi	SR 18 P (Aut)	D=35 mm / L=250 mm	491P180800
▶ 22	Drška cijevi	SR 26 P (Aut)	D=27,5 mm / L=154 mm	402P180801

Oprema  11+13



▶ = Standard



Potrošni materijal za TBI TIG gorionike

Za: TBI SR 9, TBI SR 20, TBI SR 21

Sadržaj:

Za elektrodu	Oprema za	SKU	 Standard, L=30.0 mm	 Standard, L=20.6 mm	 Standard, L=25.4 mm		
Ø 1.0 mm	-	401P200400	No. 5 Ø 8.0 mm / 5/16"	401P201107	401P201001	401P200600	401P200300
Ø 1.6 mm	TBI SR 9	401P200401	No. 6 Ø 9.5 mm / 3/8"	401P201108	401P201001	401P200601	401P200300
Ø 2.4 mm	TBI SR 20 TBI SR 21	401P200402	No. 7 Ø 11.0 mm / 7/16"	401P201109	401P201002	401P200602	401P200300
Ø 3.2 mm	-	401P200403	No. 8 Ø 12.5 mm / 1/2"	401P201110	401P201003	401P200603	401P200300

Za: TBI SR 17, TBI SR 18, TBI SR 26

Sadržaj:

Za elektrodu	Oprema za	SKU	 Standard, L=47.0 mm	 Standard, L=47.0 mm	 Standard, L=50.0 mm		
Ø 1.0 mm	-	402P170400	No. 4 Ø 6.5 mm / 1/4"	401P170907	401P180999	402P170500	402P170200
Ø 1.6 mm	TBI SR 17	402P170401	No. 5 Ø 8.0 mm / 5/16"	401P170908	401P180999	402P170502	402P170200
Ø 2.4 mm	TBI SR 18 TBI SR 26	402P170402	No. 6 Ø 9.5 mm / 3/8"	401P170909	401P181000	402P170503	402P170200
Ø 3.2 mm	-	402P170403	No. 7 Ø 11.0 mm / 7/16"	401P170910	401P181001	402P170504	402P170200
Ø 4.0 mm	-	402P170404	No. 8 Ø 12.5 mm / 1/2"	401P170911	401P181002	402P170505	402P170200



TIG DODAVAČI ŽICE



Za: TBi SR 9, TBi SR 20, TBi SR 21

481P101023

Više detalja o samom dijelu može se pronaći u tehničkoj dokumentaciji



Za: TBi SR 17, TBi SR 18, TBi SR 26

481P101024

Više detalja o samom dijelu može se pronaći u tehničkoj dokumentaciji



Za: TBi XCT 200W, TBi XCT 400W

481P101028

Više detalja o samom dijelu može se pronaći u tehničkoj dokumentaciji



TBi WIG/TIG pribor



TBi TIG montažni uređaj prikladan je za obje veličine TBi Precision ručke.

WKZP200000

TBi TIG gorionici mogu se precizno pozicionirati i fiksirati u montažnom elementu. Olakšava sve radove montaže na otvorenoj ručki, koji se na ovaj način mogu obaviti sigurno i profesionalno.



TBi Wolfram elektrode

- U skladu sa standardom DIN EN ISO 6848
- Kvaliteta iz europske proizvodnje

*Dostupne boje:
Zlatna, siva, zelena i plava*

Zasebne letke o TBi TIG elektrodama moguće je pogledati na našim WEB stranicama

Spremni smo za sutra!

© 2021 TBI Industries GmbH. Sva prava sadržana. Nije dopuštena promjena bez dopuštenja. Izvadc i prepisi nisu dopušteni. Nr.DOKP12101C,02/2021.

TBI Industries GmbH
Ruhberg 14
35463 Fernwald-Steinbach
Germany

Tel. +49 6404 9171-0
Fax. +49 6404 9171-58
www.tbi-industries.com
info@tbi-industries.com