

IK-72T

All Position Oxy-Fuel Cutting Machine

Features and Benefits

- **All position oxy-fuel cutting**
Cuts flat, bended, or twisted steel plates in all positions and directions.
- **Permanent magnet rails**
Secures rail to plate; allows the rail to be used vertically.
- **Selectable rail configuration**
There are 3 unique rail types; the 2D and 3D rails can be connected to each other by use of connector kit, the 1D without.
- **Clutch lever**
Allows quick positioning of machine on rail.
- **Long flange bar option**
For cutting of longer flanges up to 700 mm in diameter.
- **Amazingly lightweight**
Only 4.5 kg and compact; machine can be carried easily anywhere.

High quality cutting in all positions

Flexibility and versatility

The IK-72T is ideal for industries which require out-of-position cutting such as ship-vessel, tank-building and repair. There are three different types of rails available.

- The straight 1D rail made of robust aluminium, allowing straight cutting on flat plate in out-of-place positioning.
- The double-plane 2D rail has a flexible steel strip inside, which makes the rail not to bend in sideways. Ideal for applications which require straight cutting line on bended plate surface such as tank fabrication.
- Triple plane 3D rail is flexible in every direction and suitable for applications which require maximum flexibility.
- All rails are delivered with magnetic holder, enabling cuts in vertical and horizontal position. For maximum magnet efficiency and reduction of rail movement, be sure to clean rusty plate before cutting.

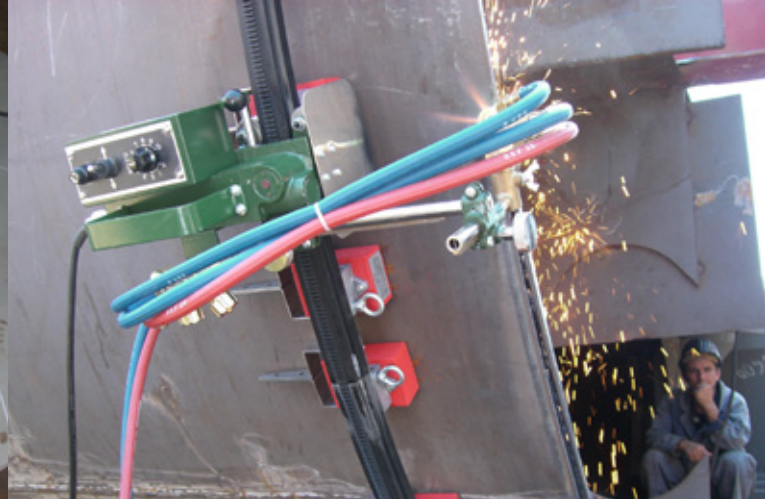
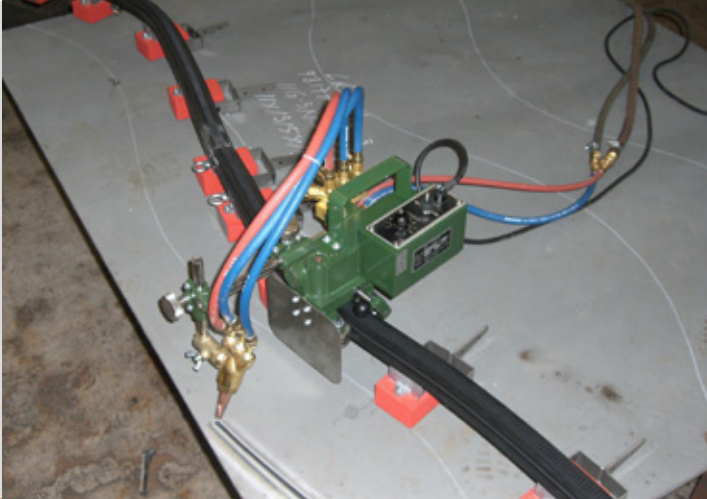

The IK-72T cuts various types of steel shapes including channel, curved plate and angled steel members. Made of an aluminium alloy, the IK-72T is lightweight and easy to handle. A graduated bevel collar is provided for bevelling. Simply adjust the scale to precise bevel angle.

Portability

The IK-72T is designed to maximize portability. Aluminium alloy body together with robust gear system made the machine to be extremely light, yet durable in heavy duty working environment.

- Light weight: 4.5 kg
- Rack and pinion drive system
- Single-action mechanical clutch system allows quick machine positioning along the rail.



Accessories	Rail selections
Accessory	Stock #
IK-72T 1D-RAIL 1500 MM	TBPJ64025
IK-72T 2D-RAIL 1000 MM	90154
IK-72T 3D-RAIL 1000 MM	TBPJ64026

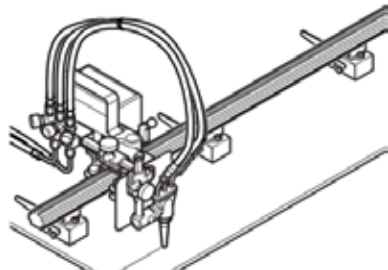

1D Rail 1500 mm

- For flat plate
- Extendable aluminium made straight rail
- Ideal for straight cutting and welding applications
- 4 pcs permanent magnets

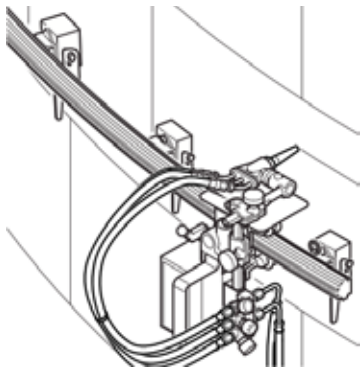
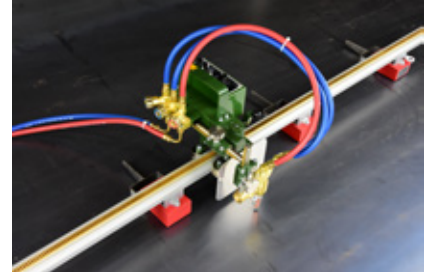

2D Rail 1000 mm

- For bended plane
- Extendable flexible rubber rail with steel plate liner; maximum bending radius 2500 mm
- 5 pcs permanent magnets

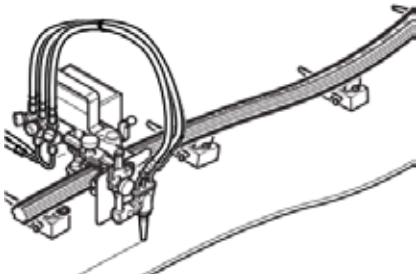
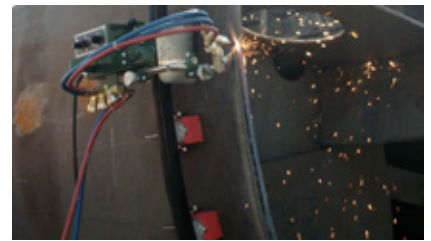

3D Rail 1000 mm

- For bended and twisted planes
- Extendable flexible rubber rail; bends in any direction
- Maximum bending radius 2000 mm
- 5 pcs permanent magnets



Optional accessories

Accessory	Stock #	Description
Rail connector	33107	Parts to connect 1D rail to 2D / 3D rail
Longer vertical bar 350L	31697	Extends torch positioning by 350 mm
Transformer AC230V - 42V	222.002.207	For 42V models
Transformer AC230V - 110V	90100	For 110V models



Transformer

Rail connector
Different rail types can be connected and combined with the rail connector.





Overhead cutting made possible with strong permanent magnets.

Specification	IK-72T
Cutting thickness	5 - 50 mm
Cutting speed	150 - 700 mm
Type of drive	PWM control
Bevel angle	0 ~ 45°
Driving method	Rack and pinion
Input power	AC 110V / AC 42V
Maximum rail bending radius	2D rail: 2500 mm 3D rail: 2000 mm
Dimension	L250 x W300 x H190 mm
Weight	4.5 kg

Types	
Model	Stock #
IK-72T Machine body 42V	90152
IK-72T Machine body 110V	90151

Scope of delivery	
Machine body with torch set	
Cutting nozzles (102HC or 106HC, size #0, 1, 2)	
Power cable	
Standard tool set	
Operation manual	



EMEA Sales and Service Offices

FRANCE

KOIKE France S.A.R.L.
ZAC de la Vallée de L'aunelle
RN Cellules C1 à C4
59144 Wargnies-Le-Grand
T: +33 327304343

GERMANY

KOIKE EUROPE B.V. Germany Branch Office
Im Löchel 2
35423 Lich-Eberstadt
T: +49 6004916930

ITALY

KOIKE ITALIA Srl
Via Papa Giovanni XXIII, n 45
20053 - Rodano (Milano)
T: +39 0295328717

UAE

KOIKE MIDDLE EAST FZE
SAIF Zone Sharjah - UAE
P.O. Box 122978
T: +971 561177615

THE NETHERLANDS

KOIKE EUROPE B.V.
Grote Tocht 19
1507 CG Zaandam

T: +31 (0)75 612 72 27
F: +31 (0)75 612 34 61

info@koike-europe.com
www.koike-europe.com

R•A•M